

**INTRODUCTION** The pellet stove is a heating device with internal combustion that takes the air from the room and transforms it into hot air.

The heat process is generated by the fuel (the pellet) and combustion (the air) which combination results as:

- 1) Energy, the flame, consequently heat
- 2) Combustion residue that is not transformed in energy, the ash

To optimize the production of the energy, we should know the chemical composition of the pellet wood and consequently calculate the volume of air requested to burn it, optimizing the combustion. This ratio is called stoichiometric ratio.

As much as closer we can get the stove working with the ideal stoichiometric ratio, compared to the chemical composition of the pellet, the better is the combustion and the production of energy.

## WHAT IS THE RDS TECHNOLOGY AND HOW IT WORKS !?

The RDS system gives the possibility to the stove to constantly control the volume of air requested for the combustion, in relation to the ideal stoichiometric ratio preset by us.

The system adapts itself to different working conditions such as:

- Different wood pellet quality : the stoichiometric ratio change, the RDS system "feel" the different requirement of air and "order" the stove to reset the preset ratio
- Different size of the chimney : the stoichiometric ratio change, the RDS system "feel" the different requirement of air and "order" the stove to reset the preset ratio.

With the RDS system, the stove is always working with the ideal efficiency, adapting itself to different conditions of combustion air and the chemical composition of pellet.

## THE FLOW METER



**FLOW METER** Is the instrument that can measure the flow of air requested for the combustion. Connected to an electronic device, measuring the speed of the air, it can adjust the correct volume of air requested for the combustion of the stove.

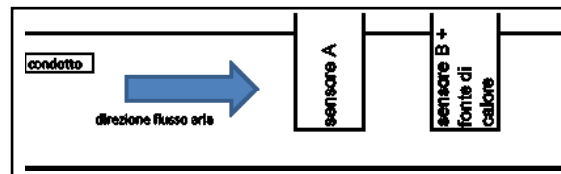

Is the instrument that can measure the flow of air requested for the combustion. Connected to an electronic device, measuring the speed of the air, it can adjust the correct volume of air requested for the combustion of the stove.

There are two temperature sensors; a simple one (sensor A) and a second one, similar to the first one, but preheated (sensor B).

The temperature values detected by the two sensors are different.

The sensor A feels the room temperature, while the sensor B feels the temperature of the preheated sensor.

Placing the two sensors of the flow meter in a tube where a flow of air is passing, the temperature of the sensor B will reduce depending from the speed of the air passing inside the tube; values change depending from the speed of the air passing inside the tube.

The main electronic board can detect the temperature modification of the two sensors and can calculate the speed of the air accordingly.

If we multiply the value by the diameter of the tube, you will get the flow of air in m<sup>3</sup>/s passing through the system. In a volume (m<sup>3</sup>) there is a specific mass of air; multiplying this value for the flow of air, we can obtain the mass of air entering in the combustion chamber of the stove.

## FUNTIONNING OF THE STOVE WITH RDS TECHNOLOGY

### 2.1. STARTING MESSAGE

After few seconds from switching on of the power, the following messages are displayed:

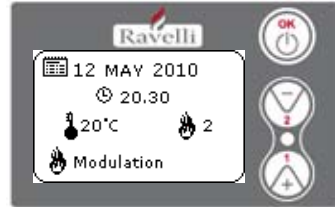
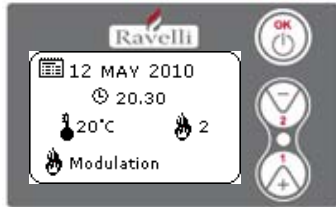

### 2.2. START UP CONDITON OF THE STOVE

There are two start up conditions of the stove:

- Cold ignition (t. smokes  $\leq$  then the switch off parameter TF15)
- Hot ignition or "restart" (t. smokes  $>$  lower then switch off parameter TF15)

#### 2.2.1 "COLD" IGNITION PHASE – STOVE STATUS "COLD"

This phase refers to every ignition phase with a temperature below the minimum threshold (TF15)

A pellet stove is working with 5 different phases:

- A – IGNITION PHASE
- B – FLAME STABILISATION PHASE
- C – WORKING PHASE
- D – MODULATION PHASE
- E – CONFORT CLIMA ACTIVATION PHASE
- F – SWITCHING OFF PHASE

#### A - IGNITION PHASE

Stove in "FINAL CLEANING" or "OFF, with attempt to ignite" : 

-If the temperature of the smokes is higher than the parameter TF15 ( $T_{\text{smoke}} > TF15$ ), the stove continue the cleaning phase.

-if the temperature of the smokes is less or equal off threshold ( $T_{\text{smoke}} \geq TF15$ ), a TF45 timer is activated (RE-IGNITION BLOCK) THE DISPLAY SHOWS "FAN WAITING IGNITION": at the end of this time, the stove goes on IGNITION phase.

**IMPORTANT** : the above-mentioned timer (TF45) has been introduced in order to guarantee that there is no flame or unburned pellet inside the fire pot before the stove switch on.

**DISPLAY SHOWING "START" : in his phase the ignitor is pre-heated for a preset time, connected to parameter TF 04. In this phase, the loading of the pellet starts according to TF01.**

**DISPLAY SHOWING "WAITING FLAME" : in this phase, while the ignitor is still workings, loading of the pellet continue, the smoke fan starts and the flow meter starts to measure the flow of combustion air passing from the firepot and set the air volume as per the value TF 03 (the rpm of the smoke fan varies in order to keep a constant the volume of air). In this moment, the T0 value is memorized as a reference to read the smoke temperature increase (TF05 DELTA FLAME) and determine later the stove to pass into phase "FLAME LIGHT". The loading of the pellet is regulated by TF01 which indicates the ON values of the gearmotor. To prevent a surplus of pellet into the firepot, we activated a parameter TF02 that limit the loading time of the pellet during all start up procedure.**

**NB. :** If in the working time set for the auger to feed the pellet (TF 02), the motherboard read an increase of temperature equal to the value set in the parameter TF 05, the stove pass from the phase WAITING FLAME Into the phase FLAME LIGTH, without considering this time.

**NB.:** if the motherboard does not feel an increase of temperature equal to the value set in TF05 within the time of “time out” (TF 48), the stove pass into “NO INGNITION ALARM”.

## B) Flame stabilization phase

**DISPLAY SHOWING “FLAME LIGTH” :** *in this phase the ignitor goes automatically in OFF status; the flow of air goes at a value set by parameter TF10. The functioning of the auger is set by parameter TF08 the flame has few minutes (TF09) to get stabilized.*

During this working phase, which duration is measured in minutes (TF09), a check is done on smoke temperature. The system memorize the smoke temperature T0 at the beginning of this phase.

Then, every one minute, a test is done to be sure that the smoke temperature increase regularly; in the contrary, the display will show “AL11 – WRONG FLAME”.

## C – WORKING PHASE

**DISPLAY SHOWING “WORK” :** *the stove perform all power from PT01 to PT05 and then goes to working power set by the customer, while the heat exchanger, if the parameter TF 06 “fan threshold” is achieved, it goes to the working speed set by the customer.*

**When the stove reaches the working phase , reaching the preset power, the air flow and the auger operate according to parameters set for the working power selected (TF 17 – TF 20 – TF23 – TF 26 – TF 29) for the air, TF16 – TF19 – TF 22 – TF 25 – TF 28 for the auger, TF 18 - TF 21 – TF 24 – TF 27 – TF 30 for the heat exchanger)**

Each time a working power is modified, the stove reaches the set power increasing or decreasing stepless, the power as follow:

DECREASE IN POWER		INCREASE IN POWER	
Power	Time	Power	Time
from P5 to P4	40”	from P1 to P2	40”
from P4 to P3	40”	from P2 to P3	40”
from P3 to P2	40”	from P3 to P4	40”
from P2 to P1	40”	from P4 to P5	40”

If, during the work phase, the smoke temperature reaches the maximum threshold (TF 42) the stove goes into ventilation to reduce the smoke temperature. If the ventilation is not sufficient and the temperature continues to increase, reaching 269 ° C/ 516 F the stove automatically goes into „SMOKE OVER TEMPERATURE ALARM“.

If the switchboard indicates a constant decrease in temperature due to extinction of the flame, the stove goes to “NO PELLETT ALARM” reaching the threshold set in the parameter TF 41 (“NO PELLETT THRESHOLD”) .

**IMPORTANT!!!** Even if the smoke temp. reaches the value set in the TF 06, the exchanger does not switch on until the stove goes to WORK mode; this condition is necessary in order to avoid “jumps” in the Tsmoke in FLAME LIGHT, with the risk of displaying an unusual AL 11 FLAME ANOMALY ALARM.

**THE DISPLAY SHOWS “FIRE POT CLEANING”:** *in this phase the stove cleans the fire pot according to the interval between cleaning operations of TF 13. The duration of each cleaning operation is regulated by the parameter TF 12. The smoke extractor turns according to the TF 14 settings with a pellet load of TF 11. The purpose of this function is to prevent the basket from clogging when the stove remains in operation for many hours during the day.*

## Accensione (Fase A-B-C)

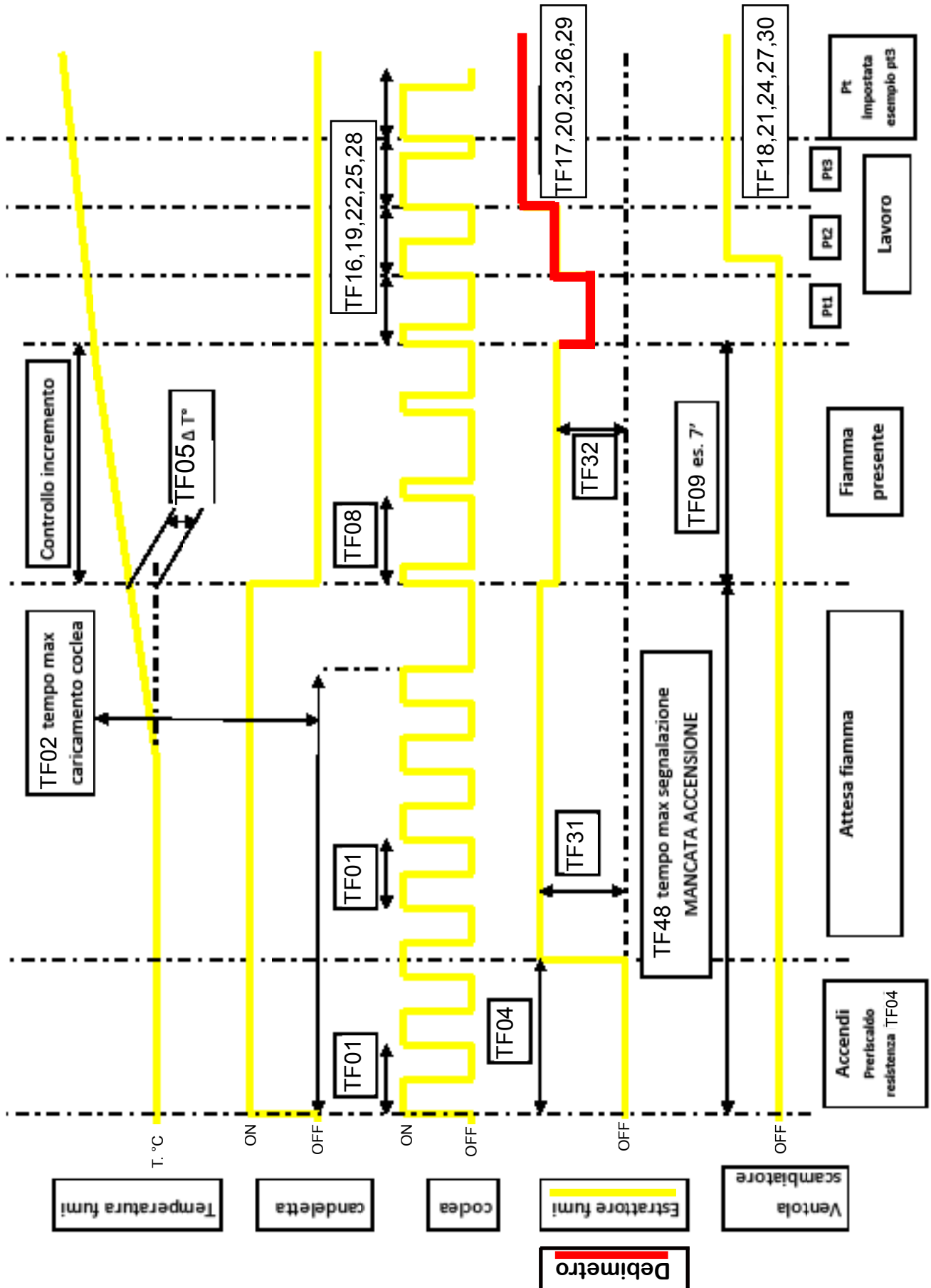

## D- Modulation phase

**THE DISPLAY SHOWS "MODULATION WORK": when the set room temperature is reached, independently from the working power of the stove, it goes to working power 1.**

## E - Comfort clima

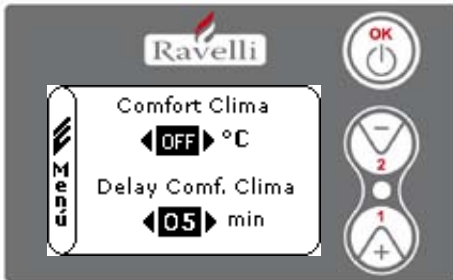

To activate the comfort clima please set a value different from OFF using keys 1 and 2. Then confirms with OK.

Set the time during which the stove should stay in MODULATION WORK before going into ECO STOP (default 4').

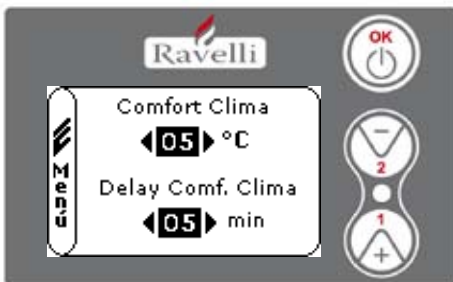

The set value (in this case 5°C) has activated the function Comfort Clima. FUNCTIONING:

The value control the restart temperature of the stove.

EXAMPLE:

- Room temperature set at 21°C.
- Comfort clima value set at 5°C.

With this regulation the stove will switch off once reached the 21°C and will switch on when the room temperature is 15°C (21°C-5-0,5 tolerance = approximately 15°C). on the display will appear the lines as in the picture on the left.

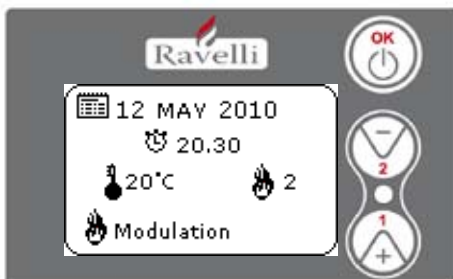

The modulation phase is activated because the set room temperature has been reached. If this temperature is keep for the set time of "DELAY COMFORT CLIMA" the stove switch off.

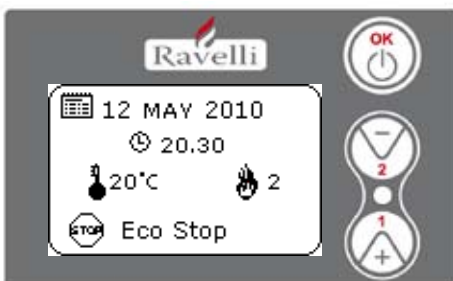

After the switching off phase the writing ECO STOP will appear on the display. The stove will remain in this status until decrease to 15°C, only at that time the starting phase will begin.

**REMARK: the functioning of the stove with COMFORT CLIMA mode could activate the ignition and the switching off phase several times during the day; this could compromise the duration of the candle for the automatic ignition of the stove.**

**F - Switching off phase**

**THE DISPLAY SHOWS "FINAL CLEAN":** The switch-off button is pressed, the pellet loading gear-motor is switched off, the smoke extractor goes to maximum power and the heat exchanger runs at power 5. When the smoke temperature reaches TF 15 (EXTINCTION THRESHOLD), the final clean continues according to time TF 46 (MIN: EXTINCTION T.) switching off the smoke extractor when this expires. The heat exchanger switches itself off according to the TF 06 ("EXCHANGER THRESHOLD") settings.

**GRAFICO SPEGNIMENTO**

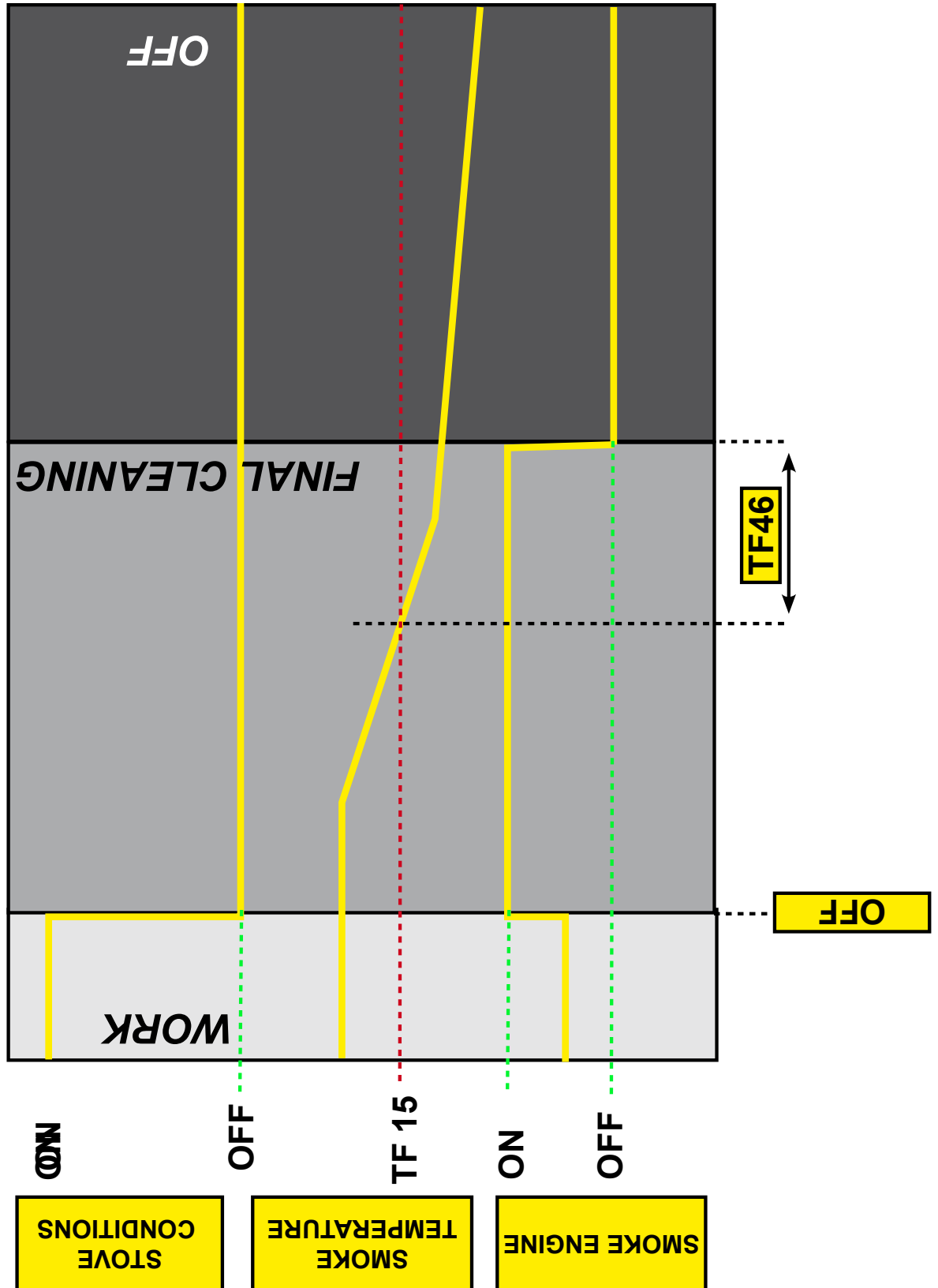

## 4.2.2 “HOT” RE-IGNITION PHASE - STOVE STATUS “HOT“

This phase refers to every ignition cycle with temperature below the re-start threshold (TF 07), in any case over the minimum threshold (TF 15, say when the stoves is already hot).

**N.B. : the value relating to the restart threshold is a datum tested in the company on each of our stove models in order to identify the optimal restart condition. This parameter should not be changed significantly by the service centre (not over 5° C/10° F) unless Ecotek technical centre has been consulted.**

A pellet stove in these conditions functions in 5 phases:

**A** - RE-IGNITION PHASE

**B** - FLAME STABILISATION PHASE (see previous section)

**C** - WORK PHASE (see previous section)

**D** - MODULATION PHASE (see previous section)

**E** - COMFORT CLIMATE ACTIVATION PHASE (see previous section)

**D** - SWITCH OFF PHASE (see previous section)

### **A – Re-ignition phase**

*Re-ignition conditions:*

Stove in “FINAL CLEAN” with re-ignition attempt:

- if the smoke temperature is lower than or the same as the restart threshold ( $T_{\text{smoke}} \leq TF07$ ), and in any case over PR13 “SWITCH OFF PHASE”, the SWITCH OFF PR” switches on the TF 45 timer (RE-IGNITION BLOCK). After the time the stove goes into re-ignition state;

- if the smoke temperature is higher than the restart threshold ( $T_{\text{smoke}} > TF07$ ) the stove continues with the final clean; after this threshold has been reached, the TF45 (RE-IGNITION BLOCK) timer switches on and the stove goes into that re-ignition state;

In both cases, during the period before re-ignition, the message “FAN WAITING RE-IGNITION” will appear on the display.

RE-IGNITION : pre-heating of the ignitor for an established time, linked to the parameter “PREHEATING TIME TF04”. In this phase pellet loading starts according to TF01 while the smoke extractor, which previously was carrying out the final clean, slows its revs and positions itself on the value set at TF09 (fan speed in FLAME PRESENT phase).

**IMPORTANT!!! This method makes it possible to solve the problem with the smoke extractor, which, passing from the OFF phase to the activation phase, could cause an anomalous increase in temperature which could elude the TF05 “FLAME DELTA “ when a flame is present.**

**N.B. : For all the other phases, the stove behaves in the same operating way as a normal ignition (See paragraph 1.2.1 from point B).**

## Riaccensione

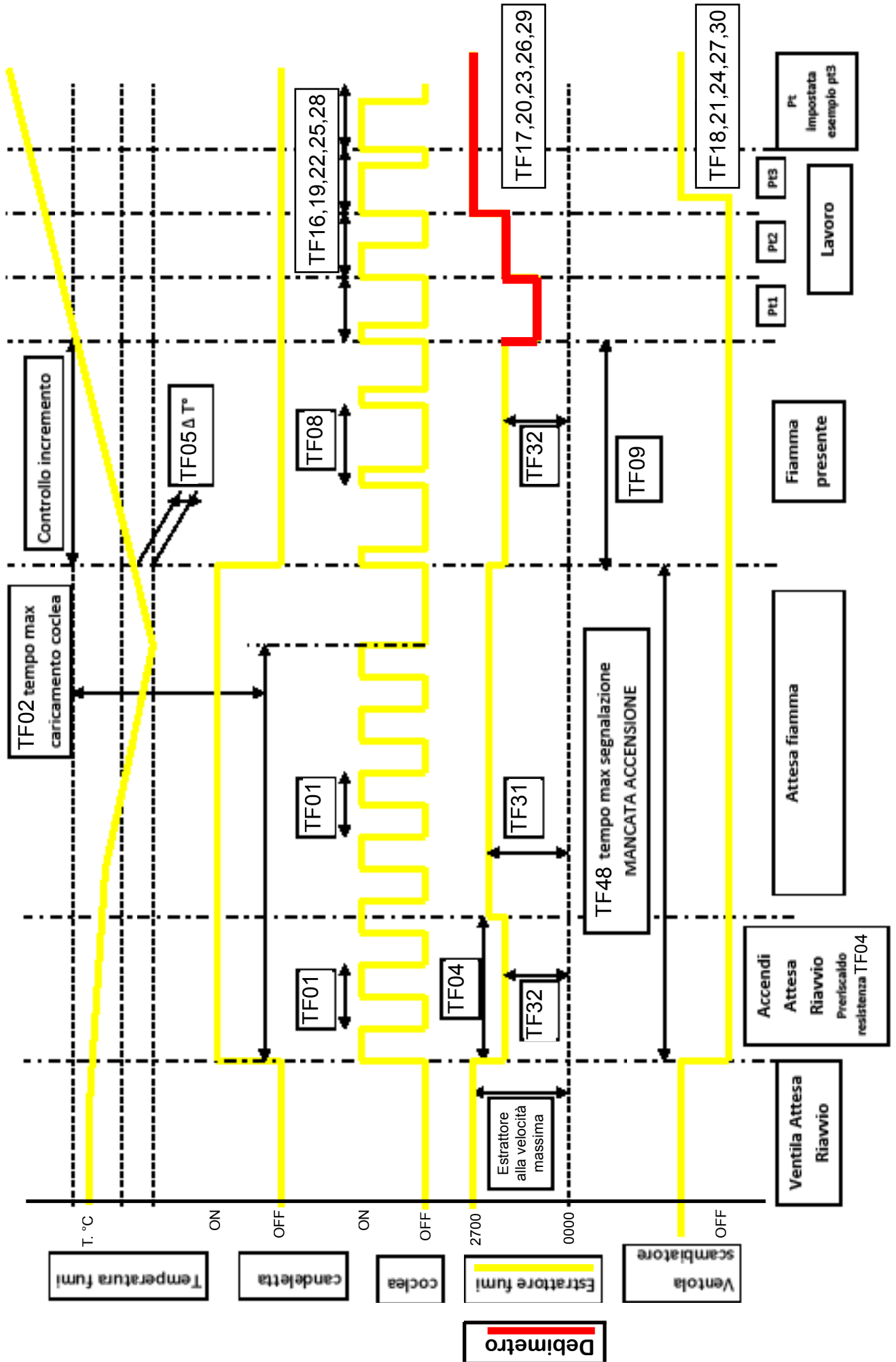



### 3.Description of the functioning and symbology of the display

The innovation of this particular display is the communication through low voltage conveyed waves (12 volts) between the electronic motherboard and the display. The communication is made through a bipolar cable (ex: the cable for the stereo speakers) and the novelty is the possibility to install the display in the wall using the optional standard frame for electrical box 503.



#### 3.1. Display with mode "BASE"

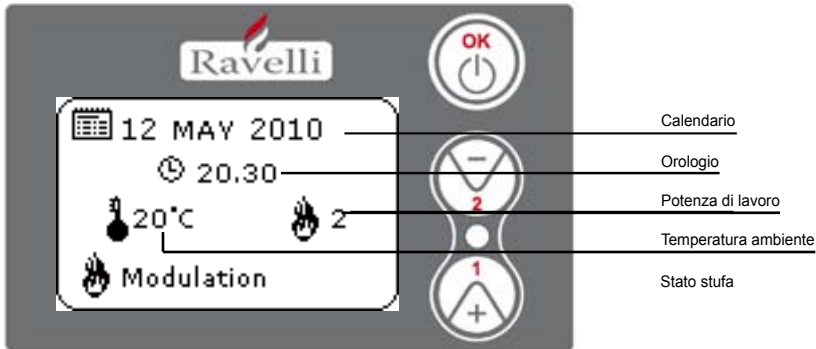

Key "1": access key to "set room temperature" and regulation

Key "2": access key to "set power" and regulation

Key "OK": short press of the key to confirm and come back to the main screen; press the key 3 seconds long to switch on and switch off the stove.

The functionalities of this display when used in mode "BASE" are:

- Switch on and switch off of the stove
- Set of the room temperature and selection of the type of sensor (supplied sensor connected to the motherboard or sensor integrated to the display)
- Set of the working power (1,2,3,4,5)

##### 3.1.1. switch on and switch off of the stove

Before starting the stove please follow following procedure :

- 1- Connect the power cable
- 2- Set the switch on the backside of the stove on position 1
- 3- Check that the installation is connected to the chimney
- 4- Load the pellet tank with 6 mm pellets
- 5- Load the screw as described in paragraph 8.6
- 6- Press key OK for 3 seconds long.

At this stage the stove will begin the ignition phase.

On the display will appear following writings:

- START (waiting time is different depending on default settings)
- WAITING FLAME (waiting time is different depending on default settings)
- FLAME LIGHT (waiting time is different depending on default settings)
- WORK (waiting time is different depending on default settings)

##### 3.1.2. Set of the room temperature

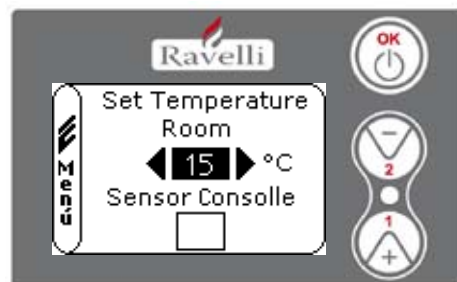
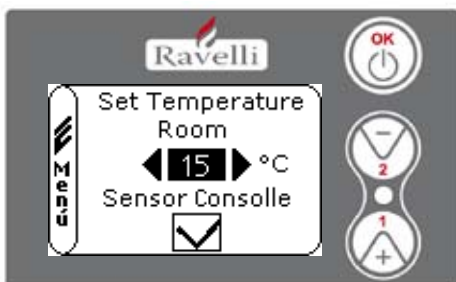

The functioning of the stove with room thermostat activated is of 3 types:

- With supplied room sensor positioned on the backside of the stove ( not available for insert models)
- With room sensor integrated to the display
- With external thermostat (not supplied)

##### MODE WITH SUPPLIED ROOM SENSOR (DEFAULT AND SUGGESTED USE)

If you use the supplied room sensor , the display will show the room temperature.

To set and modify the room temperature press key number 1 to enter in the dedicated menu and set the desired value with key 1 and 2. Confirm with key OK 2 times and keep deselected the box SENSOR CONSOLLE (flag, see pic.2). Once reached the set temperature the display will show MODULATION WORK, so the stove will reduce to minimum the pellet consumption and the power as well.

Confermare con il tasto OK due volte mantenendo deselezionata la casella (flag, vedi fig. 2) **Sonda Consolle**.  
 Al raggiungimento della temperatura, sul display verrà visualizzata la scritta LAVORO MODULA, in questo caso la stufa ridurrà al minimo il consumo dei pellet diminuendo la potenza di riscaldamento.

### MODE WITH ROOM SENSOR INTEGRATED TO THE DISPLAY

in case you want to install the display on the wall instead of on the stove as from the factory, please reference to the functioning with supplied room sensor (as above explicated) with just one difference: the box (flag) SENSOR CONSOLLE, if you work in this mode, should be selected by using key 2. Then confirm with the key OK (reference to pic. 1 paragraph 7.1.2.)

### MODALITA' TERMOSTATO ESTERNO

if you use an external thermostat correctly connected as shown in the electrical scheme (reference paragraph 10), the display will not show the room temperature but the writing T ON (when the contact is closed) or T OFF (when the contact is open).

REMARK: TO ENABLE THE EXTERNAL THERMOSTAT ENTER IN THE SET TEMPERATURE USING KEY 1 AND THEN PRESS REPEATEDLY TO REACH THE VALUE "EST" ON THE DISPLAY; CONFIRM TWO TIMES WITH THE KEY OK KEEPING DESELECTED THE BOX (FLAG) "SENSOR CONSOLLE".

Once reached the set temperature of the thermostat the display will show MODULATION WORK, so the stove will reduce to minimum the pellet consumption and the power as well. If activated the mode COMFORT CLIMA, the stove will switch on and off automatically (for details reference paragraph 8.2.)

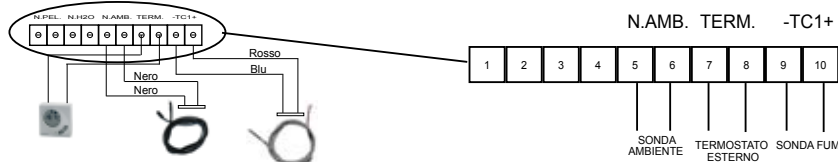

**REMARK: if you want to use the COMFORT CLIMA is advisable an external thermostat with OFF-SET of at least 3°C.**

### 3.1.3. set of the working power

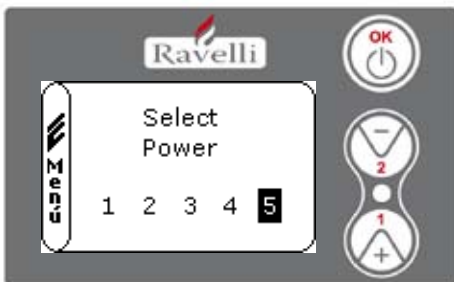

To modify the working power press key 2 to enter in the dedicated menu and with keys 1 and 2 to set the power you desire from 1 to 5 and confirm with key OK. Increasing the power also the pellet consumption and the speed of the fan increase as well. It is not possible to modify the set power during the phase of MODULATION WORK.

### 3.2. Display with mode "ADVANCED"

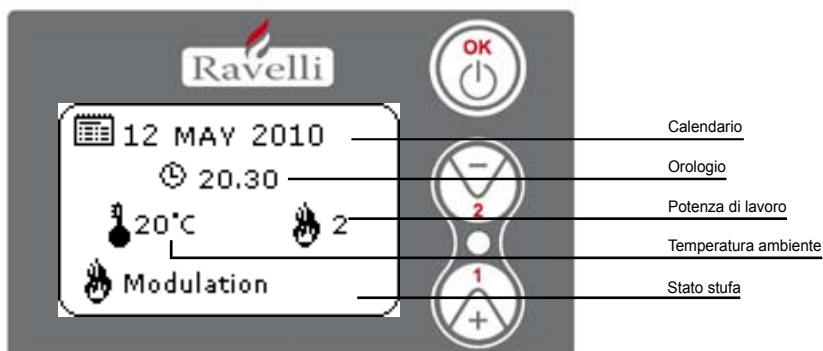

**Key "OK": access key to the complete menu and confirmation of the settings chosen**

**Key "1": scroll key and modification of the settings**

**Key "2": scroll key and modification of the settings**

The stove is equipped with many functions available in each menu programming. Some of these menu are accessible for the end user, other are protected with a password so they are accessible only for the After sales center.

The three pictures which follow show the menu with all its icons for the advanced functionalities

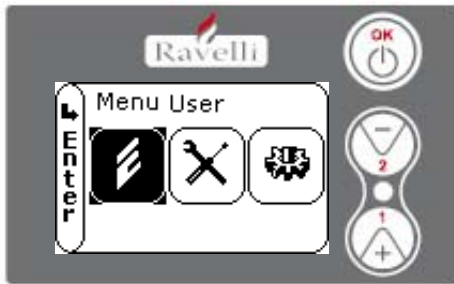

The use of the display in advanced mode provides the view of three main menus:

- USER MENU
- DEFAULT SETTINGS (protected by a password)
- BASIC PARAMETERS (protected by a password)

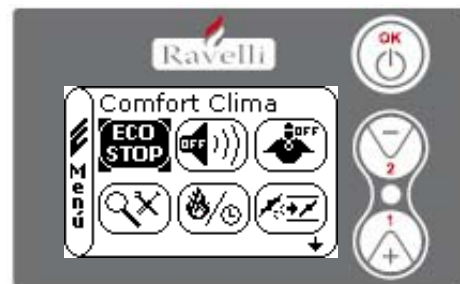
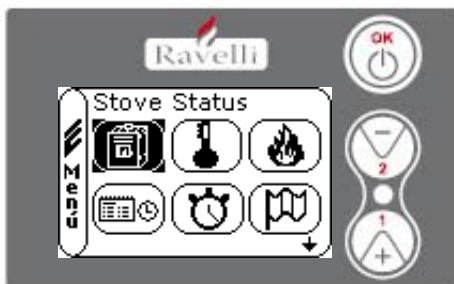

The submenus of the USER MENU (the only one accessible for the end user) are the following:

- Menu STOVE STATUS
- Menu SET ROOM TEMPERATURE
- Menu SET POWER
- Menu SET CLOCK
- Menu CHRONOTHERMOSTAT
- Menu LANGUAGE
- Menu COMFORT CLIMA
- Mode SILENCE
- Mode SELF CONTROL SYSTEM
- Menu VIEW SETTINGS
- Menu VIEW WORKING HOURS
- Menu SET DRAUGHT/PELLET

### 3.2.1 Menu "STOVE STATUS"

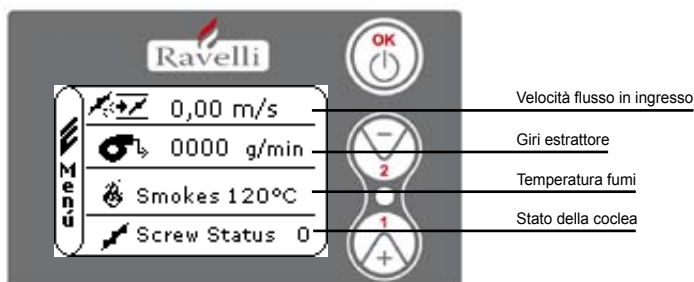

In this menu you can check the correct functioning of the most important components of the pellet stove, and some values which distinguish its correct functioning.

To enter in this menu press 3 times the key OK after having selected the icon with the writing "Stove status".

This menu is used both by the after sale center to understand the reason of the malfunctioning of the stove and by the end user as well for the pellet loading in the tank.

### 3.2.2. menu "SET ROOM TEMPERATURE"

To enter in the USER MENU press two times key OK.

To enter in the menu "SET ROOM TEMPERATURE" press once key 2 and confirm with OK.

TO MODIFY THE SETTING PLEASE REFERENCE TO PARAGRAPH 7.1.2.

To return to the main screen press at the same time keys 1 and 2.

Alternatively it is possible to exit by step from the menus by pressing each time the key OK.

### 3.2.3. menu "SET POWER"

To enter in the USER MENU press two times key OK.

To enter in the menu "SET POWER" press 2 times key 2 and confirm with OK.

TO MODIFY THE SETTING PLEASE REFERENCE TO PARAGRAPH 7.1.3.

To return to the main screen press at the same time keys 1 and 2.

Alternatively it is possible to exit by step from the menus by pressing each time the key OK.

### 3.2.4. Menu "SET CLOCK"

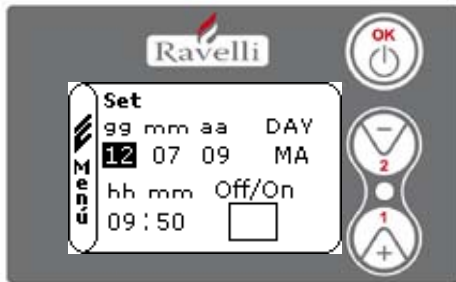

To enter in the USER MENU press two times key OK.

To enter in the menu "SET CLOCK" press 3 times key 2 and confirm with OK. To modify the settings use keys 1 and 2 and by pressing OK you confirm the data and go on to the following one. By activating the box (flag) ON/OFF you enable the function chrono ( see paragraph 7.2.5.)

By last confirmation with OK you save all settings and return automatically to the screen with the icons.

To return to the main screen press at the same time keys 1 and 2.

Alternatively it is possible to exit by step from the menus by pressing each time the key OK.

### 3.2.5. Menu "CHRONOTHERMOSTAT"

With the function chrono thermostat is possible to program for each day of the week the switch on and off of the stove in two independent intervals time (PROGRAM 1 and PROGRAM 2).

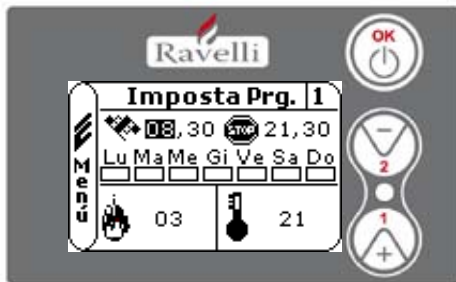

 START: orario di accensione del crono (programma1-programma2)

 STOP: orario di spegnimento del crono (programma1-programma2)

 GIORNO: giorni in cui si desidera attivare i programmi

 POTENZA: potenza desiderata al momento dell'accensione della stufa

 TEMPERATURA: temperatura ideale che si vuol raggiungere nell'ambiente in cui la stufa è installata durante l'avvio con crono attivo. Il settaggio in questione viene sovrascritto a quello impostato in condizioni di lavoro manuale.

To enter in the USER MENU press two times key OK.

To enter in the menu "SET POWER" press 4 times key 2 and confirm with OK.

To choose the programming use keys 1 and 2; confirms with OK.

- Program 1: use keys 1 and 2 to modify the settings and by each press of OK you confirm the data and go on to the following one.

- Program 2: use keys 1 and 2 to modify the settings and by each press of OK you confirm the data and go on to the following one.

By last confirmation with OK you save all settings and return automatically to the screen with the icons.

To return to the main screen press at the same time keys 1 and 2.

Alternatively it is possible to exit by step from the menus by pressing each time the key OK.

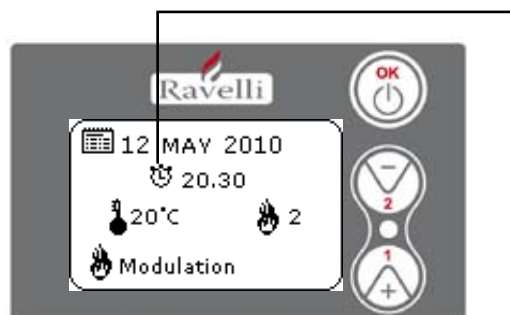

Il simbolo indicato segna che è attiva la funzione crono. E' comunque possibile effettuare la programmazione del crono anche se questo risulta disattivato. Per renderla funzionante fare riferimento al capitolo dedicato all'impostazione dell'orologio (5.2.4 MENU OROLOGIO).

## DESCRIZIONE DELLE STRINGHE :

Descrizione	Valori impostabili
START PROG - 1	Da OFF a 23:50 a step di 10'
STOP PROG - 1	Da OFF a 23:50 a step di 10'
GIORNO PROG - 1	Tra on/off per i giorni da lunedì a domenica
POTENZA PROG - 1	Da 01 a 05
SET TAMB PROG - 1	Da EST a MAN
START PROG - 2	Da OFF a 23:50 a step di 10'
STOP PROG - 2	Da OFF a 23:50 a step di 10'
GIORNO PROG - 2	Tra on/off per i giorni da lunedì a domenica
POTENZA PROG - 2	Da 01 a 05
SET TAMB PROG - 2	Da EST a MAN

## ESEMPIO:

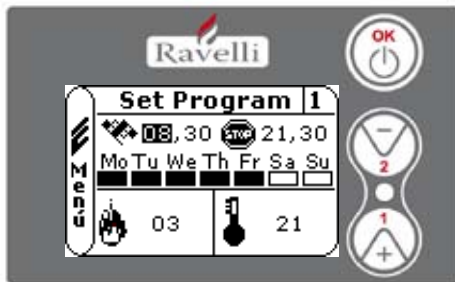

Suppose that the user want to switch on the stove at 08:30 with set switch off at 21:30 all days of the week with the exception of the weekend (PROGRAM 1), suppose moreover that the user want a room temperature of 21°C and to reach this temperature he sets a working power of 3. The passages to do will be the following:

- From the MENU CHRONO confirm with key OK and set the program you want to modify using key 1 and 2;
- By confirming with key OK you go to the set of the switch on hour, set the hour (hh:mm) using keys 1 and 2;
- By confirming with key OK you go to the set of the switch off hour, set the hour (hh:mm) using keys 1 and 2;
- By confirming with key OK you go to the scroll of the days, with keys 1 and 2 activate/deactivate the days (ex: Monday, Tuesday, Wednesday, Thursday and Friday active).
- By confirming with key OK you go to the set of the power, with keys 1 and 2 set the value (ex: Power 3).
- By confirming with key OK you go to the set of the room temperature, with keys 1 and 2 set set the degrees (ex: 20°C).

When the stove is working and the set room temperature is reached the stove goes into MODULATION or COMFORT CLIAMA (if activated).

## **! IMPORTANT**

**BY USING THIS MODE IT IS NECESSARY TO CHECK THAT AFTER EVERY AUTOMATIC SWITCHING OFF THE FIREPOT IS ALWAYS WELL CLENAED IN ORDER TO GUARANTEE A PERFECT AUTOMATIC IGNITION.**

### 3.2.6 menu "LANGUAGE"

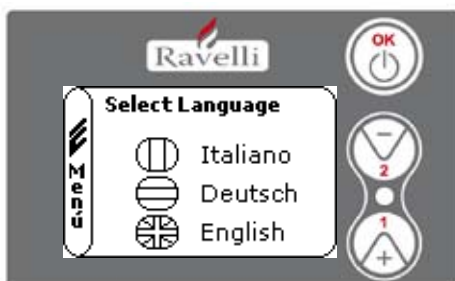

To enter in the USER MENU press two times key OK.

To enter in the menu "SET LANGUAGE" press 5 times key 2 and confirm with OK. To select language please use keys 1 and 2.

By last confirmation with OK you save all settings and return automatically to the screen with the icons.

To return to the main screen press at the same time keys 1 and 2.

Alternatively it is possible to exit by step from the menus by pressing each time the key OK.

### 3.2.7. Menu "COMFORT CLIMA"

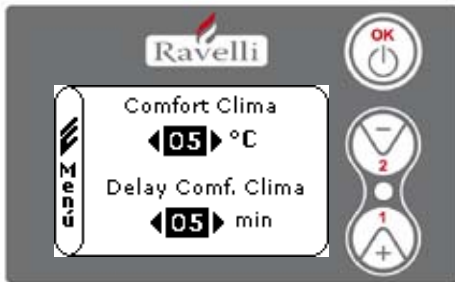

To enter in the USER MENU press two times key OK.

To enter in the menu "COMFORT CLIMA" press 6 times key 2 and confirm with OK. To modify the settings use keys 1 and 2 and by pressing OK you confirm the data and go on to the following one.

By last confirmation with OK you save all settings and return automatically to the screen with the icons.

To return to the main screen press at the same time keys 1 and 2.

Alternatively it is possible to exit by step from the menus by pressing each time the key OK.

### 3.2.8. Mode "SILENCE"

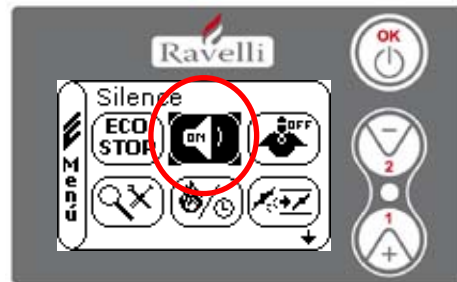
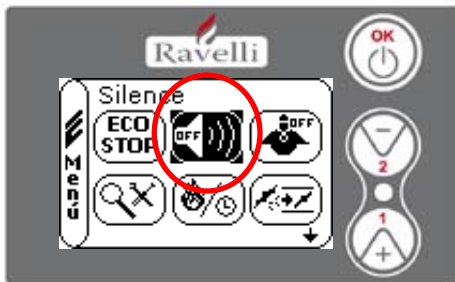

To enter in the USER MENU press two times key OK.

To enter in the MODE SILENCE press 7 times key 2 and confirm with OK. Enable or disable the function by using key OK.

To return to the main screen press at the same time keys 1 and 2.

Alternatively it is possible to exit by step from the menus by pressing each time the key OK.

### 3.2.9 Mode "SELF CONTROL SYSTEM"

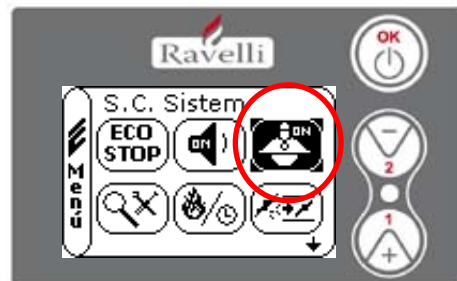
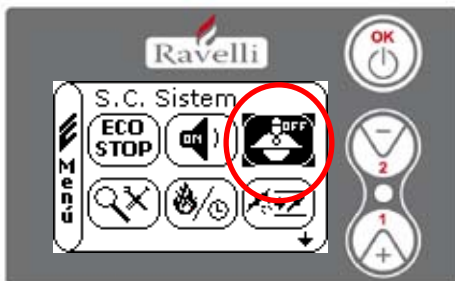

To enter in the USER MENU press two times key OK.

To enter in the MODE S.C.SYSTEM press 8 times key 2 and confirm with OK. Enable or disable the function by using key OK.

To return to the main screen press at the same time keys 1 and 2.

Alternatively it is possible to exit by step from the menus by pressing each time the key OK.

### 3.2.10 Menu "VIEW SETTINGS"

In this menu you can verify the parameters set in the motherboard.



To enter in the USER MENU press two times key OK.

To enter in the menu "VIEW SETTINGS" press 9 times key 2. By confirming with OK you enter in the list of set parameters. To scroll the list of parameters use key 1 and 2.

To return to the main screen press at the same time keys 1 and 2.

Alternatively it is possible to exit by step from the menus by pressing each time the key OK.

### 3.2.11. Menu "VIEW WORKING HOURS"

In the menu VIEW WORKING HOURS you can check the total or partial working hours and also the number of ignitions of the stove. It is possible sometimes that the working hours are not reset and you see numbers like 5000/15000/25000. It will be care of the technician to re-set these numbers by first ignition. This does not means that the stove has already worked for so many hours, it is just a setting made during the tests we make in Ravelli, before the stoves are packed and delivered. This menu is used by the After Sales Center to evaluate the total working hours of the stove during the season and consequently to evaluate the need of cleaning ("service hours").

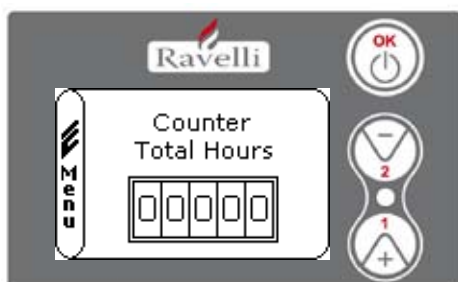

To enter in the USER MENU press two times key OK.

To enter in the menu "VIEW WORKING HOURS" press 10 times key 2. By confirming with OK you see the working hours of the stove. To scroll the different counters (total or partial hours and number of ignitions) use key 1 and 2.

To return to the main screen press at the same time keys 1 and 2.

Alternatively it is possible to exit by step from the menus by pressing each time the key OK.

### SERVICE HOURS

All our models need in addition to the regular cleaning (reference to the paragraph dedicated to the maintenance of the stove in the user manual), also a special cleaning which should be done by the installer (authorized by the producer).

At the time of the installation it is possible to set a number of working hours appropriate for the model following this procedure default settings>>extra parameters>>TF53 service hours. At the end of these hours on the display will appear the message "SERVICE HOURS" followed by an acoustic signal. When this message appears please contact the installer to do the special cleaning of the stove.

If the cleaning is not done the message will appear by each ignition but will not interrupt the functioning of the stove.

### 3.2.12 Menu "SET ARIA/PELLET"

The set of the draught-pellet blend allow to modify immediately the quantity of inlet air and the quantity of pellet loaded in the firepot.

The stove is tested with pellet certified DIN PLUS. If you do not use certified pellet could be necessary to set the combustion. Normally the modification is made on the "% FLUX" to adjust the inlet air and consequently the combustion; if the regulation of the flux is not sufficient could be necessary to adjust also the "% PELLETT".

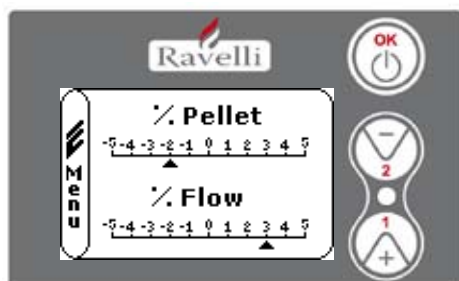

To enter in the USER MENU press two times key OK.

To enter in the menu "SET DRAUGHT/PELLET" press 11 times key 2. By confirming with OK you enter in the regulation of the blend draught/pellet. To modify the percentage use keys 1 and 2, to go from the regulation of the pellet quantity to the regulation of the inlet air flux press OK.

By last confirmation with OK you save all settings and return automatically to the screen with the icons.

To return to the main screen press at the same time keys 1 and 2.

Alternatively it is possible to exit by step from the menus by pressing each time the key OK.

**REMARK: The number indicated during the modification of the parameters refers just to a percentage value which operates on the default parameters set in the motherboard (exclusively during the working phase). These values should be modified in case of bad combustion, due many times to the different pellet quality in comparison with the one used during first ignition.**

## ! IMPORTANT

**BY USING THIS MODE IT IS NECESSARY TO CHECK THAT AFTER EVERY AUTOMATIC SWITCHING OFF THE FIREPOT IS ALWAYS WELL CLENAED IN ORDER TO GUARANTEE A PERFECT AUTOMATIC IGNITION.**

Values	Pellet
from 0 to -5	decrease of the pellet loading
0	default parameter which consider optimal the set combustion.
from 0 to 5	increase of the pellet loading

Values	Flux
from 0 to -5	set when in the stove there is no flame.
0	default parameter which consider optimal the set combustion.
from 0 to 5	to do when the pellet to use is too strong and it is necessary more air in the firepot.

**REMARK: by each step of modification corresponds variation of 5% on the pellet loading and a variation of 0,05 m/s on the flux exclusively during the working phase (TF 16, TF19, TF 22, TF 25, TF 28 fort the screw TF 17, TF20, TF 23, TF 26, TF 29 for the flux).**

### 3.3. Automatic loading of the screw

To load automatically the screw (when the stove is new or the loading sciew is empty) please do following operations:

Enter in the menu "stove status"

Coclea ferma

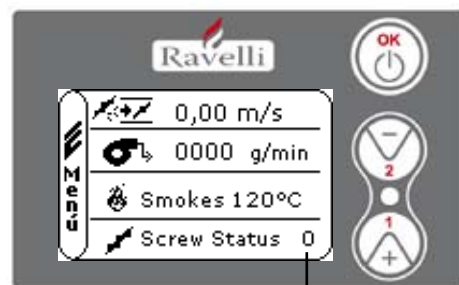

Press key OK to activate the screw

Coclea attivata

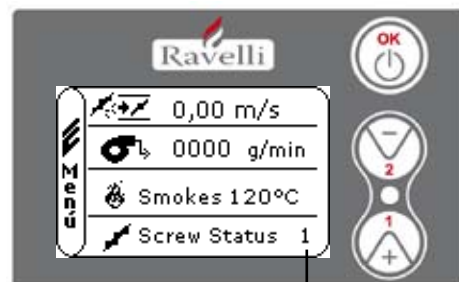

To return to the main screen press at the same time keys 1 and 2.

Alternatively it is possible to exit by step from the menus by pressing each time the key OK.

Repeat the operation several times until you see the pellet fall into the firepot.

It is possible to do this operation only if the stove is in FINAL CLEANING phase or OFF.



### 3. Description of the functioning and symbology of the display

The innovation of this particular display is the communication through low voltage conveyed waves (12 volts) between the electronic motherboard and the display. The communication is made through a bipolar cable (ex: the cable for the stereo speakers) and the novelty is the possibility to install the display in the wall using the optional standard frame for electrical box 503.



#### 3.1. Display with mode "BASE"

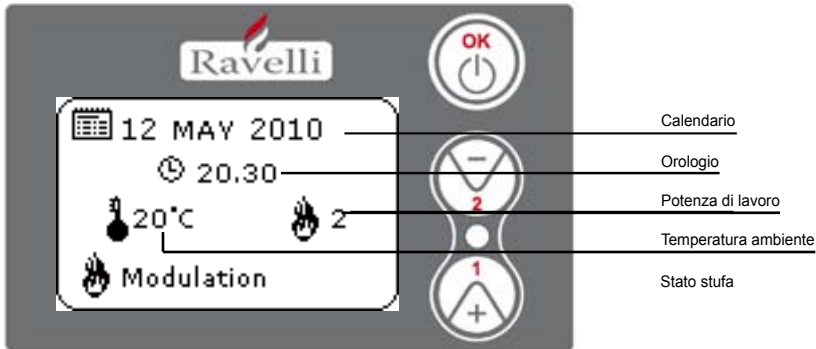

Key "1": access key to "set room temperature" and regulation

Key "2": access key to "set power" and regulation

Key "OK": short press of the key to confirm and come back to the main screen; press the key 3 seconds long to switch on and switch off the stove.

The functionalities of this display when used in mode "BASE" are:

- Switch on and switch off of the stove
- Set of the room temperature and selection of the type of sensor (supplied sensor connected to the motherboard or sensor integrated to the display)
- Set of the working power (1,2,3,4,5)

#### 3.1.1. switch on and switch off of the stove

Before starting the stove please follow following procedure :

- 1- Connect the power cable
- 2- Set the switch on the backside of the stove on position 1
- 3- Check that the installation is connected to the chimney
- 4- Load the pellet tank with 6 mm pellets
- 5- Load the screw as described in paragraph 8.6
- 6- Press key OK for 3 seconds long.

At this stage the stove will begin the ignition phase.

On the display will appear following writings:

- START (waiting time is different depending on default settings)
- WAITING FLAME (waiting time is different depending on default settings)
- FLAME LIGHT (waiting time is different depending on default settings)
- WORK (waiting time is different depending on default settings)

#### 3.1.2. Set of the room temperature

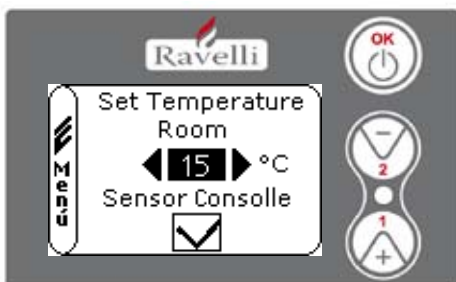

Fig. 1

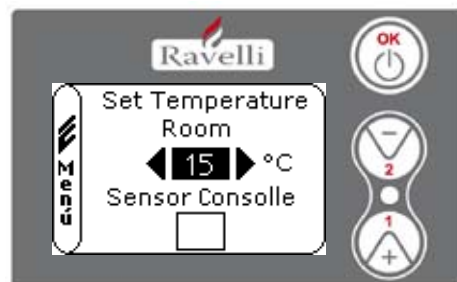

Fig. 2

The functioning of the stove with room thermostat activated is of 3 types:

- With supplied room sensor positioned on the backside of the stove ( not available for insert models)
- With room sensor integrated to the display
- With external thermostat (not supplied)

#### MODE WITH SUPPLIED ROOM SENSOR (DEFAULT AND SUGGESTED USE)

If you use the supplied room sensor , the display will show the room temperature.

To set and modify the room temperature press key number 1 to enter in the dedicated menu and set the desired value with key 1 and 2. Confirm with key OK 2 times and keep deselected the box SENSOR CONSOLLE (flag, see pic.2). Once reached the set temperature the display will show MODULATION WORK, so the stove will reduce to minimum the pellet consumption and the power as well.

Confermare con il tasto OK due volte mantenendo deselezionata la casella (flag, vedi fig. 2) **Sonda Consolle**.  
 Al raggiungimento della temperatura, sul display verrà visualizzata la scritta LAVORO MODULA, in questo caso la stufa ridurrà al minimo il consumo dei pellet diminuendo la potenza di riscaldamento.

### MODE WITH ROOM SENSOR INTEGRATED TO THE DISPLAY

in case you want to install the display on the wall instead of on the stove as from the factory, please reference to the functioning with supplied room sensor (as above explicated) with just one difference: the box (flag) SENSOR CONSOLLE, if you work in this mode, should be selected by using key 2. Then confirm with the key OK (reference to pic. 1 paragraph 7.1.2.)

### MODALITA' TERMOSTATO ESTERNO

if you use an external thermostat correctly connected as shown in the electrical scheme (reference paragraph 10), the display will not show the room temperature but the writing T ON (when the contact is closed) or T OFF (when the contact is open).

REMARK: TO ENABLE THE EXTERNAL THERMOSTAT ENTER IN THE SET TEMPERATURE USING KEY 1 AND THEN PRESS REPEATEDLY TO REACH THE VALUE "EST" ON THE DISPLAY; CONFIRM TWO TIMES WITH THE KEY OK KEEPING DESELECTED THE BOX (FLAG) "SENSOR CONSOLLE".

Once reached the set temperature of the thermostat the display will show MODULATION WORK, so the stove will reduce to minimum the pellet consumption and the power as well. If activated the mode COMFORT CLIMA, the stove will switch on and off automatically (for details reference paragraph 8.2.)

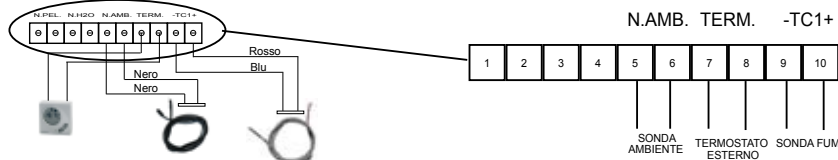

**REMARK: if you want to use the COMFORT CLIMA is advisable an external thermostat with OFF-SET of at least 3°C.**

### 3.1.3. set of the working power

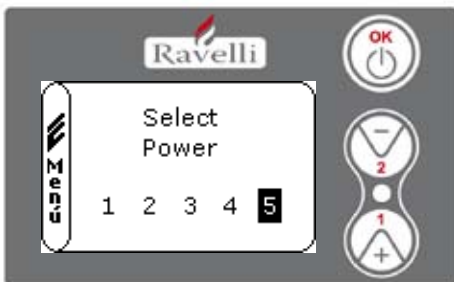

To modify the working power press key 2 to enter in the dedicated menu and with keys 1 and 2 to set the power you desire from 1 to 5 and confirm with key OK. Increasing the power also the pellet consumption and the speed of the fan increase as well. It is not possible to modify the set power during the phase of MODULATION WORK.

### 3.2. Display with mode "ADVANCED"

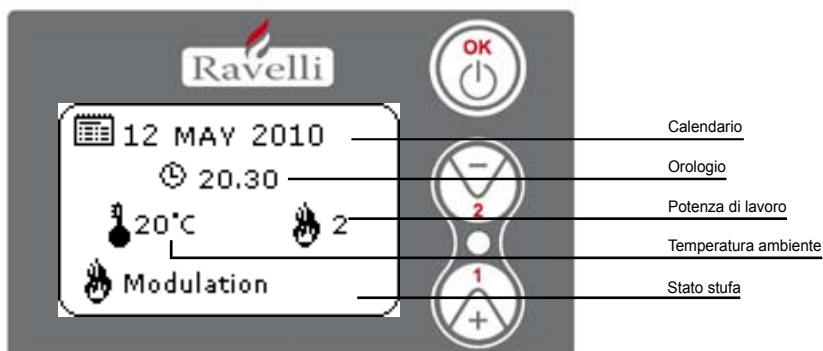

**Key "OK": access key to the complete menu and confirmation of the settings chosen**

**Key "1": scroll key and modification of the settings**

**Key "2": scroll key and modification of the settings**

The stove is equipped with many functions available in each menu programming. Some of these menu are accessible for the end user, other are protected with a password so they are accessible only for the After sales center.

The three pictures which follow show the menu with all its icons for the advanced functionalities

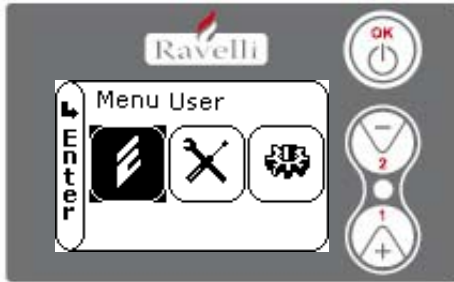

The use of the display in advanced mode provides the view of three main menus:

- USER MENU
- DEFAULT SETTINGS (protected by a password)
- BASIC PARAMETERS (protected by a password)

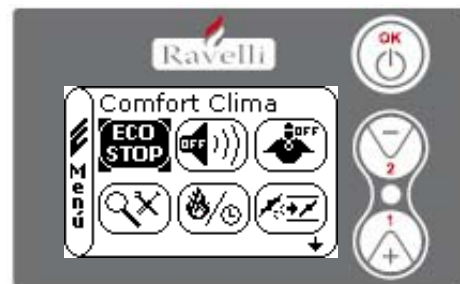
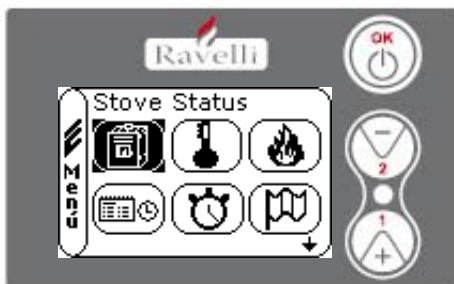

The submenus of the USER MENU (the only one accessible for the end user) are the following:

- Menu STOVE STATUS
- Menu SET ROOM TEMPERATURE
- Menu SET POWER
- Menu SET CLOCK
- Menu CHRONOTHERMOSTAT
- Menu LANGUAGE
- Menu COMFORT CLIMA
- Mode SILENCE
- Mode SELF CONTROL SYSTEM
- Menu VIEW SETTINGS
- Menu VIEW WORKING HOURS
- Menu SET DRAUGHT/PELLET

### 3.2.1 Menu "STOVE STATUS"

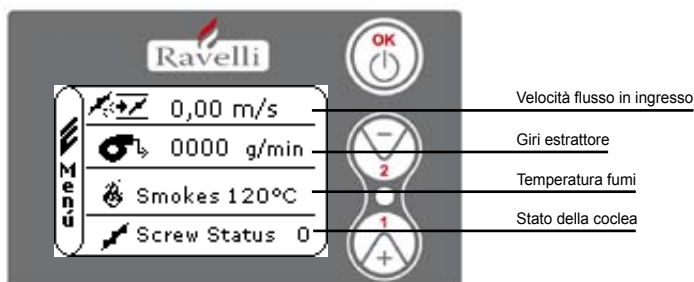

In this menu you can check the correct functioning of the most important components of the pellet stove, and some values which distinguish its correct functioning.

To enter in this menu press 3 times the key OK after having selected the icon with the writing "Stove status".

This menu is used both by the after sale center to understand the reason of the malfunctioning of the stove and by the end user as well for the pellet loading in the tank.

### 3.2.2. menu "SET ROOM TEMPERATURE"

To enter in the USER MENU press two times key OK.

To enter in the menu "SET ROOM TEMPERATURE" press once key 2 and confirm with OK.

TO MODIFY THE SETTING PLEASE REFERENCE TO PARAGRAPH 7.1.2.

To return to the main screen press at the same time keys 1 and 2.

Alternatively it is possible to exit by step from the menus by pressing each time the key OK.

### 3.2.3. menu "SET POWER"

To enter in the USER MENU press two times key OK.

To enter in the menu "SET POWER" press 2 times key 2 and confirm with OK.

TO MODIFY THE SETTING PLEASE REFERENCE TO PARAGRAPH 7.1.3.

To return to the main screen press at the same time keys 1 and 2.

Alternatively it is possible to exit by step from the menus by pressing each time the key OK.

### 3.2.4. Menu "SET CLOCK"

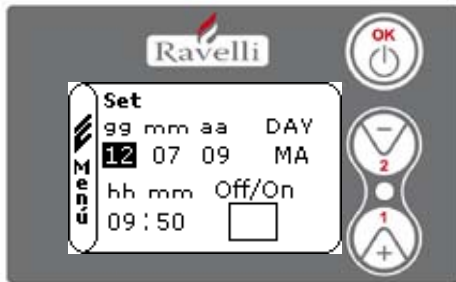

To enter in the USER MENU press two times key OK.

To enter in the menu "SET CLOCK" press 3 times key 2 and confirm with OK. To modify the settings use keys 1 and 2 and by pressing OK you confirm the data and go on to the following one. By activating the box (flag) ON/OFF you enable the function chrono ( see paragraph 7.2.5.)

By last confirmation with OK you save all settings and return automatically to the screen with the icons.

To return to the main screen press at the same time keys 1 and 2.

Alternatively it is possible to exit by step from the menus by pressing each time the key OK.

### 3.2.5. Menu "CHRONOTHERMOSTAT"

With the function chrono thermostat is possible to program for each day of the week the switch on and off of the stove in two independent intervals time (PROGRAM 1 and PROGRAM 2).

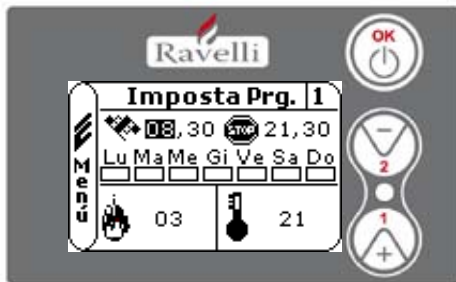

 START: orario di accensione del crono (programma1-programma2)

 STOP: orario di spegnimento del crono (programma1-programma2)

 GIORNO: giorni in cui si desidera attivare i programmi

 POTENZA: potenza desiderata al momento dell'accensione della stufa

 TEMPERATURA: temperatura ideale che si vuol raggiungere nell'ambiente in cui la stufa è installata durante l'avvio con crono attivo. Il settaggio in questione viene sovrascritto a quello impostato in condizioni di lavoro manuale.

To enter in the USER MENU press two times key OK.

To enter in the menu "SET POWER" press 4 times key 2 and confirm with OK.

To choose the programming use keys 1 and 2; confirms with OK.

- Program 1: use keys 1 and 2 to modify the settings and by each press of OK you confirm the data and go on to the following one.

- Program 2: use keys 1 and 2 to modify the settings and by each press of OK you confirm the data and go on to the following one.

By last confirmation with OK you save all settings and return automatically to the screen with the icons.

To return to the main screen press at the same time keys 1 and 2.

Alternatively it is possible to exit by step from the menus by pressing each time the key OK.

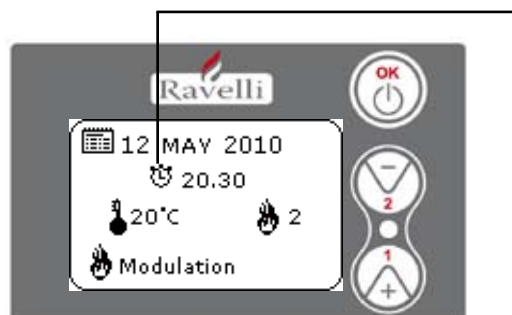

Il simbolo indicato segna che è attiva la funzione crono. E' comunque possibile effettuare la programmazione del crono anche se questo risulta disattivato. Per renderla funzionante fare riferimento al capitolo dedicato all'impostazione dell'orologio (5.2.4 MENU OROLOGIO).

## DESCRIZIONE DELLE STRINGHE :

Descrizione	Valori impostabili
START PROG - 1	Da OFF a 23:50 a step di 10'
STOP PROG - 1	Da OFF a 23:50 a step di 10'
GIORNO PROG - 1	Tra on/off per i giorni da lunedì a domenica
POTENZA PROG - 1	Da 01 a 05
SET TAMB PROG - 1	Da EST a MAN
START PROG - 2	Da OFF a 23:50 a step di 10'
STOP PROG - 2	Da OFF a 23:50 a step di 10'
GIORNO PROG - 2	Tra on/off per i giorni da lunedì a domenica
POTENZA PROG - 2	Da 01 a 05
SET TAMB PROG - 2	Da EST a MAN

## ESEMPIO:

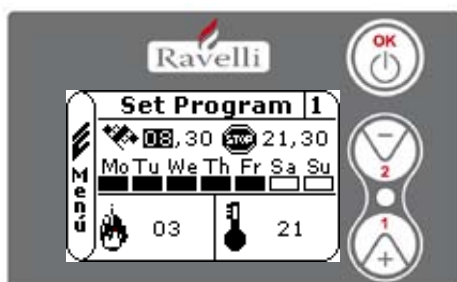

Suppose that the user want to switch on the stove at 08:30 with set switch off at 21:30 all days of the week with the exception of the weekend (PROGRAM 1), suppose moreover that the user want a room temperature of 21°C and to reach this temperature he sets a working power of 3. The passages to do will be the following:

- From the MENU CHRONO confirm with key OK and set the program you want to modify using key 1 and 2;
- By confirming with key OK you go to the set of the switch on hour, set the hour (hh:mm) using keys 1 and 2;
- By confirming with key OK you go to the set of the switch off hour, set the hour (hh:mm) using keys 1 and 2;
- By confirming with key OK you go to the scroll of the days, with keys 1 and 2 activate/deactivate the days (ex: Monday, Tuesday, Wednesday, Thursday and Friday active).
- By confirming with key OK you go to the set of the power, with keys 1 and 2 set the value (ex: Power 3).
- By confirming with key OK you go to the set of the room temperature, with keys 1 and 2 set set the degrees (ex: 20°C).

When the stove is working and the set room temperature is reached the stove goes into MODULATION or COMFORT CLIAMA (if activated).

## **! IMPORTANT**

**BY USING THIS MODE IT IS NECESSARY TO CHECK THAT AFTER EVERY AUTOMATIC SWITCHING OFF THE FIREPOT IS ALWAYS WELL CLENAED IN ORDER TO GUARANTEE A PERFECT AUTOMATIC IGNITION.**

### 3.2.6 menu "LANGUAGE"

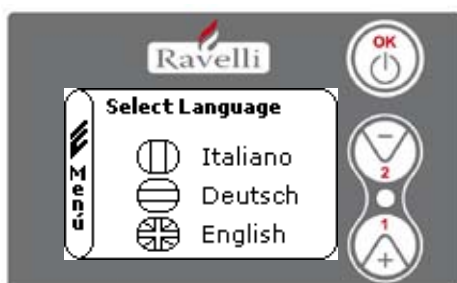

To enter in the USER MENU press two times key OK.

To enter in the menu "SET LANGUAGE" press 5 times key 2 and confirm with OK. To select language please use keys 1 and 2.

By last confirmation with OK you save all settings and return automatically to the screen with the icons.

To return to the main screen press at the same time keys 1 and 2.

Alternatively it is possible to exit by step from the menus by pressing each time the key OK.

### 3.2.7. Menu "COMFORT CLIMA"

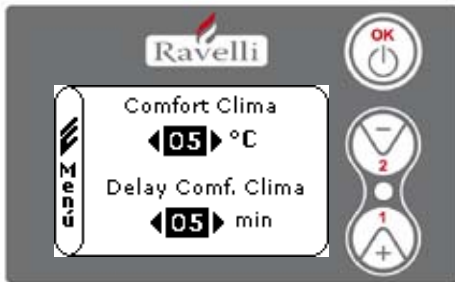

To enter in the USER MENU press two times key OK.

To enter in the menu "COMFORT CLIMA" press 6 times key 2 and confirm with OK. To modify the settings use keys 1 and 2 and by pressing OK you confirm the data and go on to the following one.

By last confirmation with OK you save all settings and return automatically to the screen with the icons.

To return to the main screen press at the same time keys 1 and 2.

Alternatively it is possible to exit by step from the menus by pressing each time the key OK.

### 3.2.8. Mode "SILENCE"

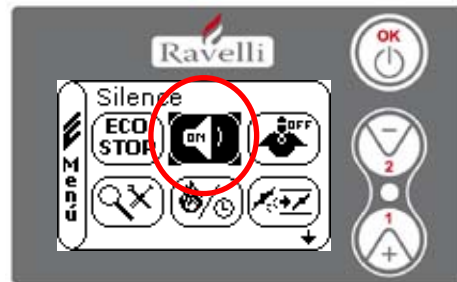
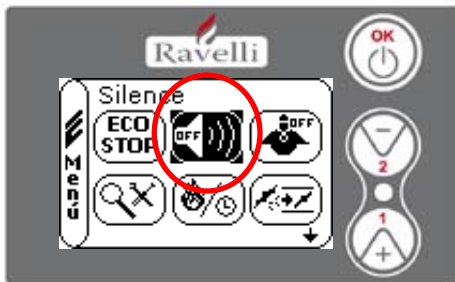

To enter in the USER MENU press two times key OK.

To enter in the MODE SILENCE press 7 times key 2 and confirm with OK. Enable or disable the function by using key OK.

To return to the main screen press at the same time keys 1 and 2.

Alternatively it is possible to exit by step from the menus by pressing each time the key OK.

### 3.2.9 Mode "SELF CONTROL SYSTEM"

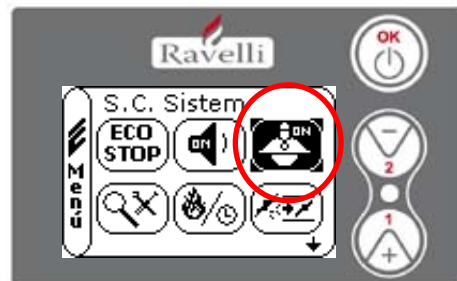
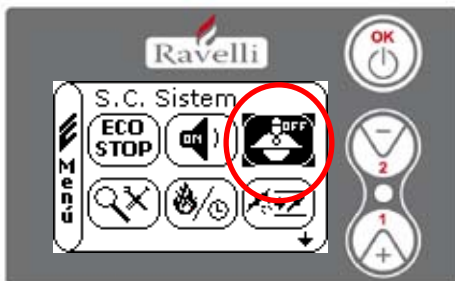

To enter in the USER MENU press two times key OK.

To enter in the MODE S.C.SYSTEM press 8 times key 2 and confirm with OK. Enable or disable the function by using key OK.

To return to the main screen press at the same time keys 1 and 2.

Alternatively it is possible to exit by step from the menus by pressing each time the key OK.

### 3.2.10 Menu "VIEW SETTINGS"

In this menu you can verify the parameters set in the motherboard.



To enter in the USER MENU press two times key OK.

To enter in the menu "VIEW SETTINGS" press 9 times key 2. By confirming with OK you enter in the list of set parameters. To scroll the list of parameters use key 1 and 2.

To return to the main screen press at the same time keys 1 and 2.

Alternatively it is possible to exit by step from the menus by pressing each time the key OK.

### 3.2.11. Menu "VIEW WORKING HOURS"

In the menu VIEW WORKING HOURS you can check the total or partial working hours and also the number of ignitions of the stove. It is possible sometimes that the working hours are not reset and you see numbers like 5000/15000/25000. It will be care of the technician to re-set these numbers by first ignition. This does not means that the stove has already worked for so many hours, it is just a setting made during the tests we make in Ravelli, before the stoves are packed and delivered. This menu is used by the After Sales Center to evaluate the total working hours of the stove during the season and consequently to evaluate the need of cleaning ("service hours").

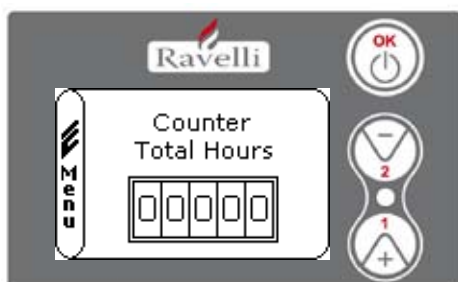

To enter in the USER MENU press two times key OK.

To enter in the menu "VIEW WORKING HOURS" press 10 times key 2. By confirming with OK you see the working hours of the stove. To scroll the different counters (total or partial hours and number of ignitions) use key 1 and 2.

To return to the main screen press at the same time keys 1 and 2.

Alternatively it is possible to exit by step from the menus by pressing each time the key OK.

### SERVICE HOURS

All our models need in addition to the regular cleaning (reference to the paragraph dedicated to the maintenance of the stove in the user manual), also a special cleaning which should be done by the installer (authorized by the producer).

At the time of the installation it is possible to set a number of working hours appropriate for the model following this procedure default settings>>extra parameters>>TF53 service hours. At the end of these hours on the display will appear the message "SERVICE HOURS" followed by an acoustic signal. When this message appears please contact the installer to do the special cleaning of the stove.

If the cleaning is not done the message will appear by each ignition but will not interrupt the functioning of the stove.

### 3.2.12 Menu "SET ARIA/PELLET"

The set of the draught-pellet blend allow to modify immediately the quantity of inlet air and the quantity of pellet loaded in the firepot. The stove is tested with pellet certified DIN PLUS. If you do not use certified pellet could be necessary to set the combustion. Normally the modification is made on the "% FLUX" to adjust the inlet air and consequently the combustion; if the regulation of the flux is not sufficient could be necessary to adjust also the "% PELLETT".

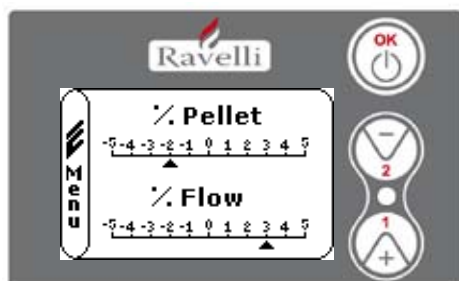

To enter in the USER MENU press two times key OK.

To enter in the menu "SET DRAUGHT/PELLET" press 11 times key 2. By confirming with OK you enter in the regulation of the blend draught/pellet. To modify the percentage use keys 1 and 2, to go from the regulation of the pellet quantity to the regulation of the inlet air flux press OK.

By last confirmation with OK you save all settings and return automatically to the screen with the icons.

To return to the main screen press at the same time keys 1 and 2.

Alternatively it is possible to exit by step from the menus by pressing each time the key OK.

**REMARK: The number indicated during the modification of the parameters refers just to a percentage value which operates on the default parameters set in the motherboard (exclusively during the working phase). These values should be modified in case of bad combustion, due many times to the different pellet quality in comparison with the one used during first ignition.**

## ! IMPORTANT

**BY USING THIS MODE IT IS NECESSARY TO CHECK THAT AFTER EVERY AUTOMATIC SWITCHING OFF THE FIREPOT IS ALWAYS WELL CLENAED IN ORDER TO GUARANTEE A PERFECT AUTOMATIC IGNITION.**

Values	Pellet
from 0 to -5	decrease of the pellet loading
0	default parameter which consider optimal the set combustion.
from 0 to 5	increase of the pellet loading

Values	Flux
from 0 to -5	set when in the stove there is no flame.
0	default parameter which consider optimal the set combustion.
from 0 to 5	to do when the pellet to use is too strong and it is necessary more air in the firepot.

**REMARK: by each step of modification corresponds variation of 5% on the pellet loading and a variation of 0,05 m/s on the flux exclusively during the working phase (TF 16, TF19, TF 22, TF 25, TF 28 fort the screw TF 17, TF20, TF 23, TF 26, TF 29 for the flux).**

### 3.3. Automatic loading of the screw

To load automatically the screw (when the stove is new or the loading scew is empty) please do following operations:

Enter in the menu "stove status"

Coclea ferma

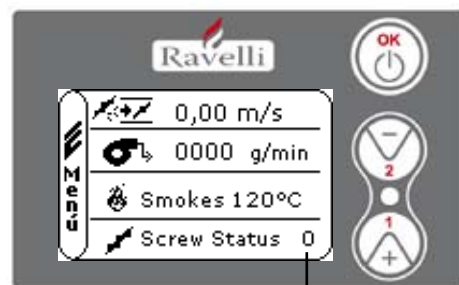

Press key OK to activate the screw

Coclea attivata

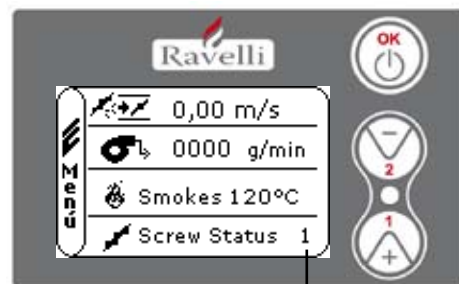

To return to the main screen press at the same time keys 1 and 2.

Alternatively it is possible to exit by step from the menus by pressing each time the key OK.

Repeat the operation several times until you see the pellet fall into the firepot.

It is possible to do this operation only if the stove is in FINAL CLEANING phase or OFF.



## 4.1 Canalizzazione singola:



Manual Function



Automatic Function

### a) Manual function (symbol on the display )

As described before, the user can easily set on the display the percentage of the hot air to deliver in a room. Here is described the procedure for the modification of the canalization following the needs of the user.

- At chapter 7.2 of the user and maintenance manual, follow the procedure to enter in the menu USER, go to the icon (fig.1) with key 2 and get access with key OK to the function "Air front/rear" to display the setting (fig.3)



Fig.1



Fig.2

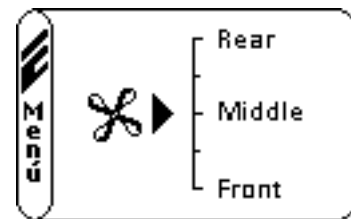



Fig.3

- Once entered in the function, choose the canalization with key 1 and 2 as described in the previous table.

**b) Automatic function (symbol on the display **): With this function, if activated, is possible to let manage independently to the stove the 5 levels of canalization. The important premise is that, by activating the automatic function, is necessary to install a room sensor (optional) or an external thermostat in the room to canalize and follow the procedure on the display:

- Enter in the page for the setting of the room temperature (reference fig. 4 and paragraph 7.2.2 of the user and maintenance manual);
- Confirm twice with key OK till the room setting of the canalization appears (fig.5)



Fig.4

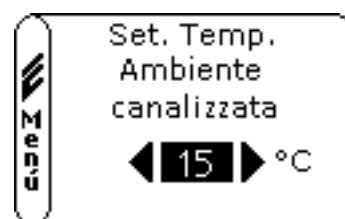
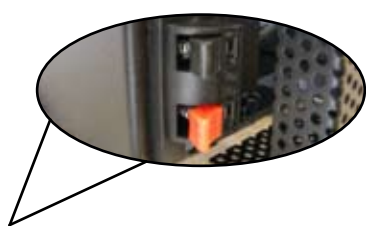
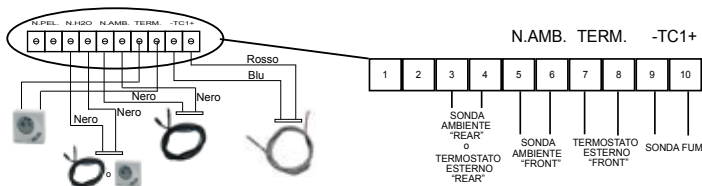

Fig.5

- Modify the room setting with key 1 and 2 , the values goes from OFF-EST -07 ...-40-MAN  
 OFF: manual function with the setting of the canalization levels done by the user  
 EST: automatic function with automatic management of the levels of the canalization following the request of an external thermostat installed in the room to canalize.  
 VALUE: automatic function with automatic management of the levels of canalization following the request of the two set room temperatures (reading of the room sensors).  
 MAN: automatic function with automatic management of the levels of canalization; the temperature of the canalization is never reached so that the canalization is always activated;

the wiring of the sensor in the motherboard should be made as in the following scheme:



Once the room sensor of the canalization is connected to the motherboard, as well as the standard display of the room temperature as in fig. nr. 6, you can read the room sensor of the canalization (fig.7). the system let modulate the stove once the set temperatures in the rooms are reached.



Fig.6



Fig.7

Attention: F means FRONT and shows the temperature measured by the sensor or the external thermostat placed in the same room where the stove is installed.

R means REAR and shows the temperature measured by the sensor or the external thermostat placed in the same room where the canalization is installed.

**IMPORTANT:** During the installation it is necessary to set the difference of the cubic volume of the rooms if you want to use in the better way the automatic function of the canalization.

The setting of the cubic volume is on three levels as in fig. 9:

= **(SAME):** IF THE CUBIC VOLUME OF THE TWO ROOMS IS MORE OR LESS SIMILAR

+ **REAR:** if the cubic volume of the room where is installed the canalization is more than the one where the stove is installed;

+ **FRONT:** if the cubic volume of the room where is installed the canalization is less than the one where the stove is installed.

To get access to the function please follow this procedure:

- At chapter 7.2 of the user and maintenance manual , follow the procedure to enter in the menu USER , go to the icon (fig.8) with key 2 and get access with key OK to the function (fig.9)



Fig.8

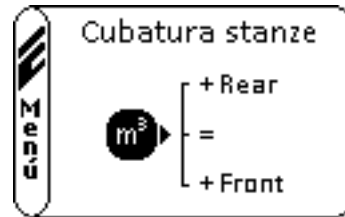
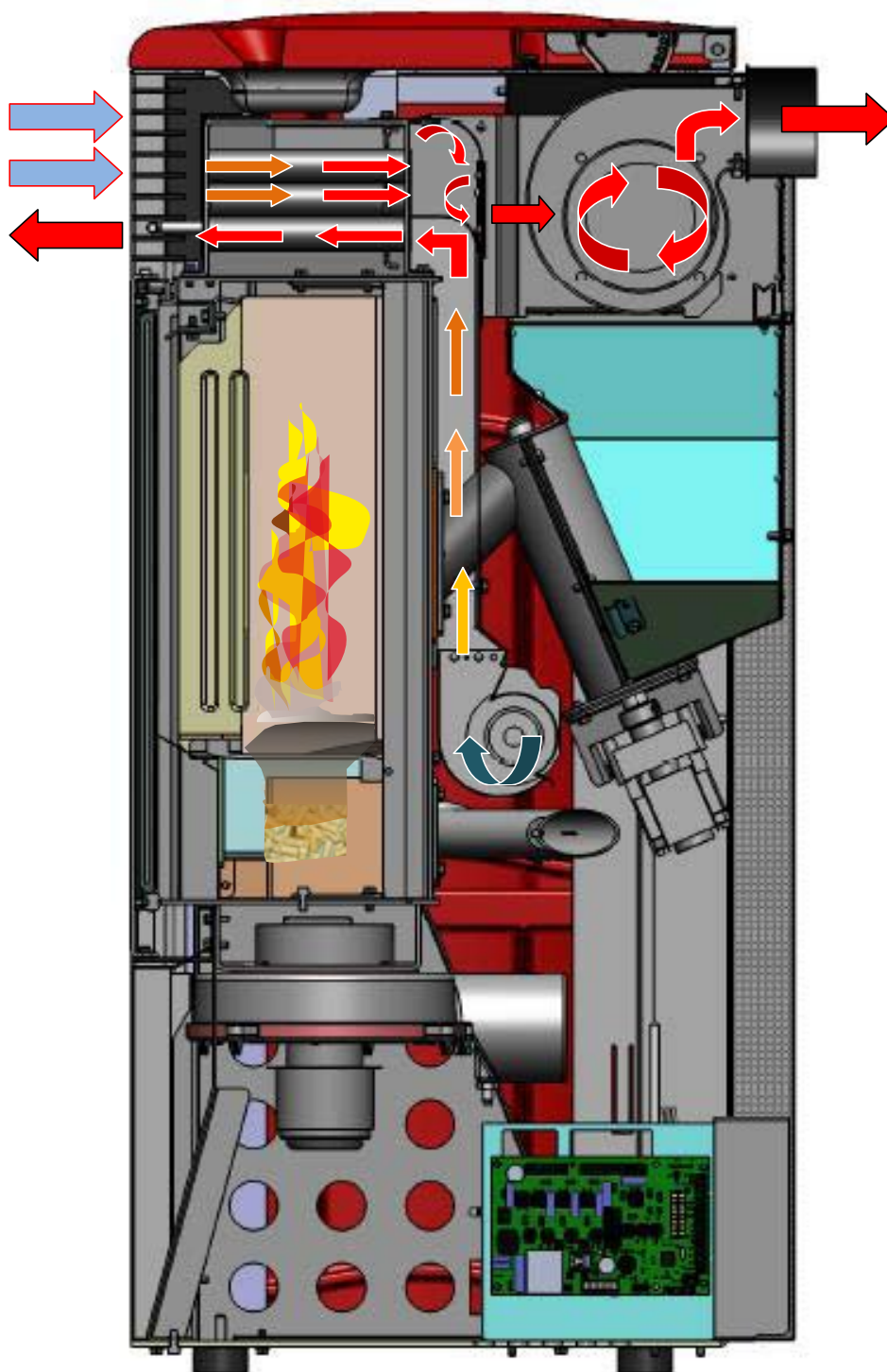

Fig.9

- Modify the cubic volume with key 1 and 2: confirm with key OK.

4.1.1



**Single duct**

The single duct has 2 air ducts , one for the heating from the front and another for the heating from the back of the stove, which are completely independent one from the other.

The heat exchanger, divided in three levels of stainless steel tubes, is based on a brand new concept for the managing of the air , which does not work anymore blowing toward the duct but with a second fan that works in aspiration, in the way that is possible to recover a bigger percentage of heat produced by the stove.

See picture above.

In the single "Flow" stove the firmware does not include the possibility to switch off the front vent ( on back mode the front vent works on minimum power).

Moreover , to prevent the risk of overheating of the stove ( hot fumi) caused by wrong settings, is not possible to set up the voltage.

## 4.2 Canalizzazione doppia:

La regolazione del flusso d'aria per la gestione della canalizzata doppia può avvenire in due modi:



Funzione MANUALE



Funzione AUTOMATICA

### a) Manual function (symbol on the display

As described before, the user can easily set on the display the percentage of the hot air to deliver in a room. Here is described the procedure for the modification of the canalization following the needs of the user.

- At chapter 7.2 of the user and maintenance manual, follow the procedure to enter in the menu USER, go to the icon (fig.1) with key 2 and get access with key OK to the function "Air front/rear" to display the setting (fig.3)



Fig.1



Fig.2

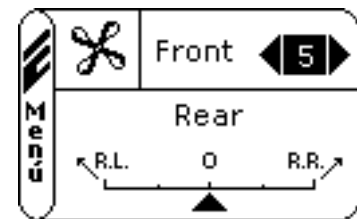

Fig.3

- Once entered in the function, choose the canalization with key 1 and 2 as described in the previous table.

### B) Automatic function (symbol on the display

With this function, if activated, is possible to let manage independently to the stove the 5 levels of canalization. The important premise is that, by activating the automatic function, is necessary to install a room sensor (optional) or an external thermostat in the room to canalize and follow the procedure on the display:

- Enter in the page for the setting of the room temperature (reference fig. 4 and paragraph 7.2.2 of the user and maintenance manual);
- Confirm twice with key OK till the room setting of the canalization appears (fig.5)



Fig.4

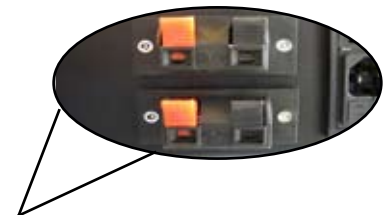
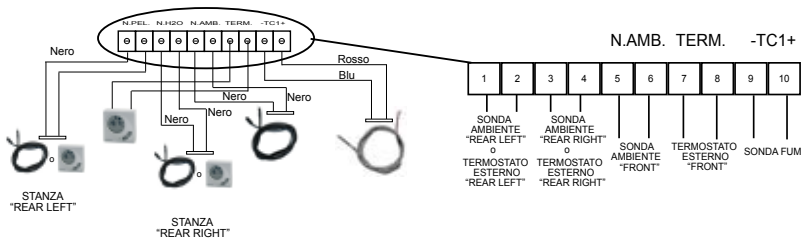

Fig.5

Modify the room setting with key 1 and 2 , the values goes from OFF-EST -07 ...-40-MAN  
 OFF: manual function with the setting of the canalization levels done by the user  
 EST: automatic function with automatic management of the levels of the canalization following the request of an external thermostat installed in the room to canalize.

VALUE: automatic function with automatic management of the levels of canalization following the request of the two set room temperatures (reading of the room sensors).

MAN: automatic function with automatic management of the levels of canalization; the temperature of the canalization is never reached so that the canalization is always activated;



Once the room sensor of the canalization is connected to the motherboard, as well as the standard display of the room temperature as in fig. nr. 6, you can read the room sensor of the canalization (fig.7). the system let modulate the stove once the set temperatures in the rooms are reached.



Fig.6



Fig.7



Fig.8

Attention: F means FRONT and shows the temperature measured by the sensor or the external thermostat placed in the same room where the stove is installed.

RR means REAR RIGHT and shows the temperature measured by the sensor or the external thermostat placed in the same room where the right canalization is installed.

RL means REAR LEFT and shows the temperature measured by the sensor or the external thermostat placed in the same room where the LEFT canalization is installed.

**IMPORTANT** : During the installation it is necessary to set the difference of the cubic volume of the rooms if you want to use in the better way the automatic function of the canalization.

The setting of the cubic volume is on three levels as in fig. 10:

= (**sAME**): IF THE CUBIC VOLUME OF THE TWO ROOMS IS MORE OR LESS SIMILAR;

+ **REAR RIGHT**: if the cubic volume of the room where is installed the RIGHT canalization is more than the one where the LEFT canalization is installed

+ **REAR LEFT**: if the cubic volume of the room where is installed the LEFT canalization is more than the one where the RIGHT canalization is installed

Per accedere alla funzione seguire la procedura:

To get access to the function please follow this procedure:

- At chapter 7.2 of the user and maintenance manual , follow the procedure to enter in the menu USER , go to the icon (fig.9) with key 2 and get access with key OK to the function (fig.10)



Fig.9

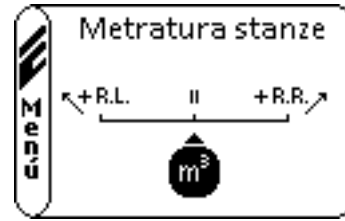

Fig.10

- Modify the cubic volume with key 1 and 2: confirm with key OK.

**Handling of the front fan:** the blower that is blowing the hot air in the front part of the stove is working independently from the set of the automatic set up of the two rear blowers for the canalization. In case the stove should be set to work in Power 5 with the canalization in position Middle, the power of the front blower can be set as follow:

0 – front blower not activated (if the front blower is deactivated during the automatic set up, the temperature value set for the front room, is no longer considered as a value that will lead the stove into modulation).

Value 1 to 5 - power of the front blower that can be adjusted independently from the power of the stove, provided in not higher than the same (only exception when the stove enter in Modulation; also the front blower goes ALWAYS at minimum power)

A – The front blower ALWAYS follow the power set in the stove.

**Remark:** With the automatic set of the canalization activated and front blower in working condition, if the two rooms temperature of the canalization is reached, but the temperature of the main room where the stove is set is not reached, the blower goes in A and when this condition is reached, the blower power can no longer be modified (can only be deactivated setting the "0")

4.2.1

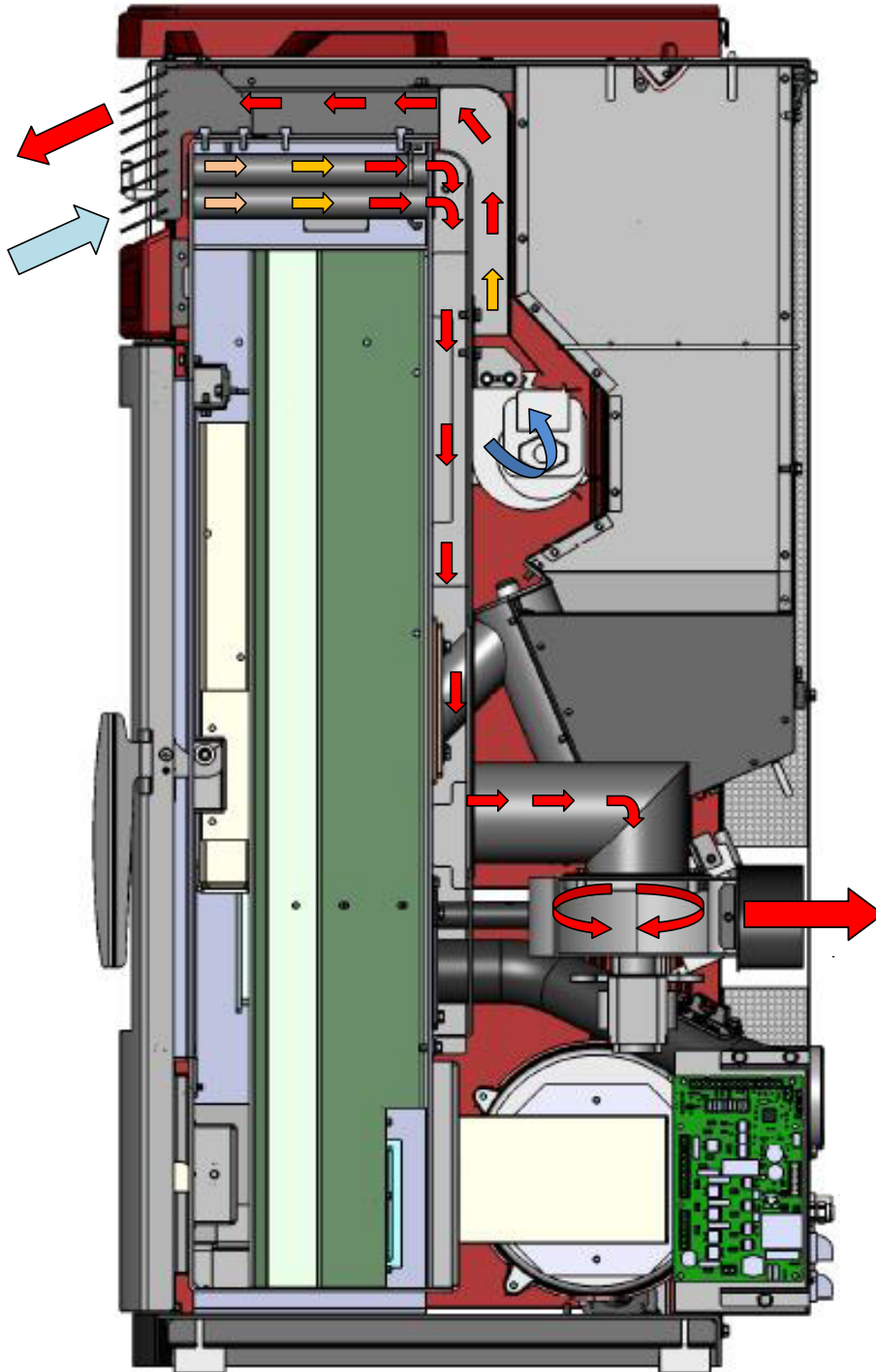

**RC - Double duct :**

The double duct stove has three air ducts , one for the heating from the front and another two for the heating from the back of the stove, which are completely independent one from the others.

The heat exchanger, divided in two levels of stainless steel tubes, is based on a brand new concept for the managing of the air , which does not work anymore blowing toward the duct, but with two fan working in aspiration, in the way that is possible to recover a bigger percentage of heat produced by the stove.

See picture above.

In the single "Flow" stove the firmware does not include the possibility to switch off the front vent ( on back mode the front vent works on minimum power).

Moreover , to prevent the risk of overheating of the stove ( hot fumi) caused by wrong settings, is not possible to set up the voltage.



## ALARMS

In the event that a functional anomaly is verified, the card intervenes, signals the irregularity and operates in different modes according to the type of alarm. The following alarms are foreseen.

Alarm origin	Code	Screen display
Temperature smoke probe	02	ALARM SMOKE PROBE
Smoke over-temperature	03	TEMP SMOKE ALARM
Failure to light	05	FAILURE TO LIGHT ALARM
Flame anomaly	11	FLAME ANOMALY ALARM
Extinction during work phase	06	PELLETS FINISHED ALARM
Failed mains power supply	01	BLACK-OUT
General safety pressure switch	08	DEPRESURIZATION ALARM
General safety thermostat	07	TEMPERATURE ALARM
Smoke fan unserviceable	04	EXTRACTOR UNSERVICEABLE ALARM
Extractor revolutions anomaly	12	EXTRACTOR REVOLUTIONS ALARM
Door open	13	INSUFFICIENT DRAFT ALARM
Brazier obstruction	13	INSUFFICIENT DRAFT ALARM
Unserviceable debimeter	09	UNSERVICEABLE DEBIMETER ALARM
Guasto al triac della coclea	15	TRIAC COCHLEA ALARM
Defective cabling	14	COCHLEA PHASE ALARM
Pressure <0,5bar or >2,5bar	16 <b>rate-determining step</b>	PRESSURE ALARM
Water heater > 90°C (TF37)	10	HOT WATER ALARM

### 8.1 Alarm 02 SMOKE PROBE

Occurs in the event of incorrect reading from the smoke probe when this turns out to be unserviceable or not connected.

### 8.2 Alarm 03 SMOKE TEMP

**Hot fumes:** Is announced not as a true alarm but as a warning of having reached the maximum TF 42 threshold. When the card signals such a condition, it intervenes by reducing the pellet load and the air inlet flow at the PT1, while leaving the exchanger fan at PT5, in order rapidly to cool the chassis and the smoke temperature.

**Smoke over-heating alarm:** Occurs when the heat of fumes fails to bring the smoke probe temperature down and this displays a temperature greater than 289°C.

### 8.3 Alarm 05 MANC ACC

Occurs if the TF 48 time has completely run down without verification of an increase of Tsmoke > TF 05 condition.

### 8.4 Alarm 11 ANOMOLOUS FLAME

Occurs if during the "FLAME PRESENT" phase an increase of the t.smoke conditions have not been verified.

### 8.5 Alarm 06 PELLETS FINISHED

Occurs if, at the end of the "STABILIZATION" phase, the temperature of the fumes does not reach the TF 41 value. Or, it may occur in the "WORK" phase, when the temperature of the fumes goes below the same TF 41 value.

### 8.6 Alarm 01 BLACK-OUT

Activates when a missing mains power condition occurs for a time greater than the TF 44 parameter.

OPERATIONAL STATUS	BLACK OUT DURATION	NEW STATUS ON RESTORATION OF MAINS VOLTAGE
OUT	any	FINAL CLEANING (*)
SWITCHING ON	any	BLACK-OUT ALARM
WORK	< TF44	WORK (*)
WORK	> TF44	BLACK-OUT ALARM
FINAL CLEANING	any	FINAL CLEANING (*)
ECO-STOP	any	ECO-STOP (*)

(\*) **does not prompt ALARM condition**

## 8.7 Alarm 08 DEPRESSURIZATION

When the pressure switch (low pressure meter) identifies a pressure below the trigger threshold, the same intervenes to remove power from the cochlea (in series with the power supply) and simultaneously allows the controller to acquire this change of status through the AL1 in CN4 terminal.

## 8.8 Alarm 07 THERMAL

When the main safety thermostat identifies a temperature greater than the trigger threshold (circa **90°C**), the same intervenes to remove power from the cochlea (in series with the power supply) and simultaneously allows the controller to acquire this change of status through the AL1 in CN4 terminal. The thermostat is usually mounted on the hopper (the threshold beyond which the device opens the contact is circa 90°C).

## 8.9 Alarm 04 EXTRACTOR (UNSERVICEABLE)

When the smoke extractor fan becomes unserviceable or the encoder does not read the number of revolutions, even if the reader cable is simply disconnected or broken.

## 8.10 Alarm 12 EXTRACTOR REVOLUTIONS

When the extractor fan works at a **speed below 15%** with respect to that set in the function parameters.

## 8.11 Alarm 13 INSUFFICIENT DRAW

When the flow value is greatly removed from the set value, for example if:

- **door open**: the flow goes below the minimum flow value (base parameter)
- **blockage in the brazier or in the smoke ducts inside the stove body**: the flow set is not reached even with the help of the extractor which due to the circumstance is driven at its maximum working level (maximum domestic network voltage). After a certain time in which the stove is in this condition, the alarm goes off.

## 8.12 Alarm 09 UNSERVICEABLE DEBIMETER

In the event in which an unserviceability is verified of the debimeter reading the input air flow.

When this anomaly occurs, the stove function is not interrupted, indeed, the machine starts to work in module mode functioning in manual (RDS removed). A periodic signal nevertheless remains active, whether visual or acoustic, indicating the type of problem.

## 8.13 Alarm 15 TRIAC COCHLEA

When the triac (which manages the ON and OFF pellet loading phases) inside the electronic card is unserviceable, the cochlea de-activates and this alarm appears on the display.

## 8.14 Alarm 14 COCHLEA PHASE

In the case in which the cochlea wiring is not correctly connected on the card or there are interruptions. Check the various connections and the condition of the cable.

## Alarms relating to the stoves (gamma HYDRO)

### 8.15 Alarm 16 PRESSURE (WATER)

In the case in which the plant pressure is greater or less than a value set by the Ravelli srl company (must be between 0.6 bar and 2.4 bar). A pressure of circa 1.0 bar is recommended at cold circuit.

### 8.16 Alarm 10 HOT WATER

If the water heater temperature exceeds 90°C (TF37) the following alarm is screened. In this case, it is important to check for correct functioning of the circulator or whether some impedance (gate valve) is causing incorrect circulation of water in the heating circuit.

**NB: Each alarm condition (excluding alarm 09) causes the immediate switching off of the stove, with the extractor active at maximum power and the exchanger at PT5 speed until reaching the dedicated TF06 threshold. The alarm status is reached after TF43 time can be zeroed by pressing the OK button.**

**IMPORTANT! Each alarm is only displayed after a time has elapsed as established in the TF 43 timer "Alarm Delay" parameter, with the exception of the "PELLET FINISHED", "BLACK-OUT" e "DEBIMETER UNSERVICEABLE" alarms.**

**IMPORTANT! When an alarm is activated, it is no longer possible to start the stove until that alarm is reset by holding the OK button pressed.**

## MEMBER OF AN OPERATING SYSTEM WITH PELLET STOVE RDS

STATUS	Code	CONDITION	PARAMETER INVOLVED IN CONDITION	MESSAGE DISPLAYED	PARAMETERS INVOLVED IN OFF
STATUS	0	if T. SMOKE < TF15 after T. MIN. POWER	TF15/TF46	STATUS	NONE (NON-OPERATING STATUS)
ON / PRE-HEATING	1	if T. SMOKE < TF15	TF15	LIGHT	TF48/TF49/TF04/TF02/TF01
		if T. SMOKE > TF15 & T. SMOKE < TF07	TF07/TF15	LIGHT UP - RESET	TF48/TF32/TF04/TF02/TF01
DELAY FLAME	2	After PRE-HEATING	TF 04	DELAY FLAME	TF48/TF31/TF02/TF05/TF01
THIS FLAME	3	After DELTA FLAME	TF05	THIS FLAME	TF09/TF08/TF32
WORK	4	After MIN. START	TF09	WORK	TF16/19/22/25/28 TF17/20/23/26/29 TF18/21/24/27/30 TF06
AIR MODULATION	4	if Amb. T. > SET Amb. T.	NONE	MODULA AIR	TF16/TF17/TF18 TF16/TF17
WATER MODULATION	4	if T.H2O > SET T.H2O	NONE	WATER MODULE	TF16/TF17
WORK MODULA	4	if H2O and T.AMB reach	NONE	WORK MODULA	TF16/TF17
CLEANING BRAZIER	5	Each CADENCE CLEANING	TF13 TF12	CLEANING BRAZIER	TF12 /TF14/TF11 TF13/TF14/TF18
CLEANING with CLEANER	4	Each CADENCE CLEANING	TF12/TF11	CLEANER ACTIVE	TF14/TF18/TF27orTF21
SWITCHING OFF	6	With Keystroke P3	NONE	FINAL CLEANING	TF15/TF06/TF46
ATTEMPT RESTART	7	if T. SMOKE < TF07 after RESTART BLOCKAGE	TF15/TF45	FAN - START DELAY	NONE (NON-OPERATING STATUS)
		if T. SMOKE > TF15 & T. SMOKE < TF07 After RESTART BLOCKAGE.	TF07/TF15/TF45	FAN RESTART DELAY	NONE (NON-OPERATING STATUS)
ECO AIR STOP	7	if Amb. T. > SET Amb. T. with CLIMATE COMFORT active	CLIMATE COMFORT DELAY SELECTED ON MENU	ECO STOP	NONE (NON-OPERATING STATUS)
AIR MODULATION with display of "AIR FLOW METER FAILURE 09."	4	Flow meter failure or disconnection	NONE	WORK MODULA	TF33-37
WORK With RDS disabled	4	After switching by OK	TF39	WORKING with a symbol on display indicating RDS off	TF16/19/22/25/28 TF18/21/24/27/30 TF06 TF33/34/35/36/37

Legend:  
COLOUR BLUE --> Function phases relating to gamma HYDRO stoves and related involved parameters.

## 10. OPERATIONS LINKED TO “FINAL CLEAN” PHASE

The purpose of the “FINAL CLEAN” phase is to burn all pellets in the fire pot during the extinction phase. In fact the smoke extractor is activated at maximum revs per minute. Its value is around 2700 rpm. In just a few minutes the surplus pellet is burnt in the basket and the stove starts the cooling phase also thanks to the support of the heat exchanger running at power of 5 until it succeeds in lowering smoke temperature till threshold TF 06.

### 10.1 “FINAL CLEAN” without Re-ignition attempt

If extinction of the stove is required, the switchboard activates the “FINAL CLEAN” phase and behaves as follows:

EXTINCTION REQUEST	CONDITIONS	OPERATION	DISPLAY	EFFECT
-OK for 4 seconds - Shut off CHRONOTHERMOSTAT ECO STOP	SMOKE TEMP.>TF15	FINAL CLEANING (until following condition)	FINAL CLEANING	OFF
	SMOKE TEMP.<=TF15	FINAL CLEANING (until timer TF46)	FINAL CLEANING	OFF
	T.FUMI<TF 15 after TIMER TF 46	//	OFF	//

After the smoke probe has reached the value set in the TF15, the TIMER TF46 (“T-MIN EXTINCTION”) is activated in order to check that the flame has gone out completely.

**IMPORTANT!!!** the TIMER mentioned above, that can be set manually by the PR40, must have a value equal to the time needed to extinguish the flame, even after the “WAIT FLAME” phase where the firepot must consume a large amount of pellets before the “OFF” status.

### 10.2 “FINAL CLEAN” with Re-ignition attempt

If a Re-ignition is requested after the “FINAL CLEAN”, the switchboard must behave as follows:

EXTINCTION REQUEST	CONDITIONS	OPERATION	DISPLAY	EFFECT
- OK for 4 seconds - Ignition with CRONOTHERMOSTAT - Ignition with COMFORT	SMOKE TEMP.>TF07	FINAL CLEANING (until next condition)	FAN WAIT RE-START	RE-START
	T.SMOKE<=TF07 & SMOKE TEMP.>TF15	FINAL CLEAN (until TF45)	FAN WAIT RE-START	RE-START
	T.SMOKE<TF07	FINAL CLEAN (until TF45 timer)	FAN WAIT RE-START	START

Before every START - RE-START phase, the stove carries out a further final clean according to TIMER TF45 (“RE-IGNITION BLOCKAGE”) in order to burn all pellets inside the fire pot.

**IMPORTANT!!!** the TIMER mentioned above, that can be set manually by the TF45, must have a value equal to the time needed to extinguish the flame, even at high temperatures.

## 11.1 Air

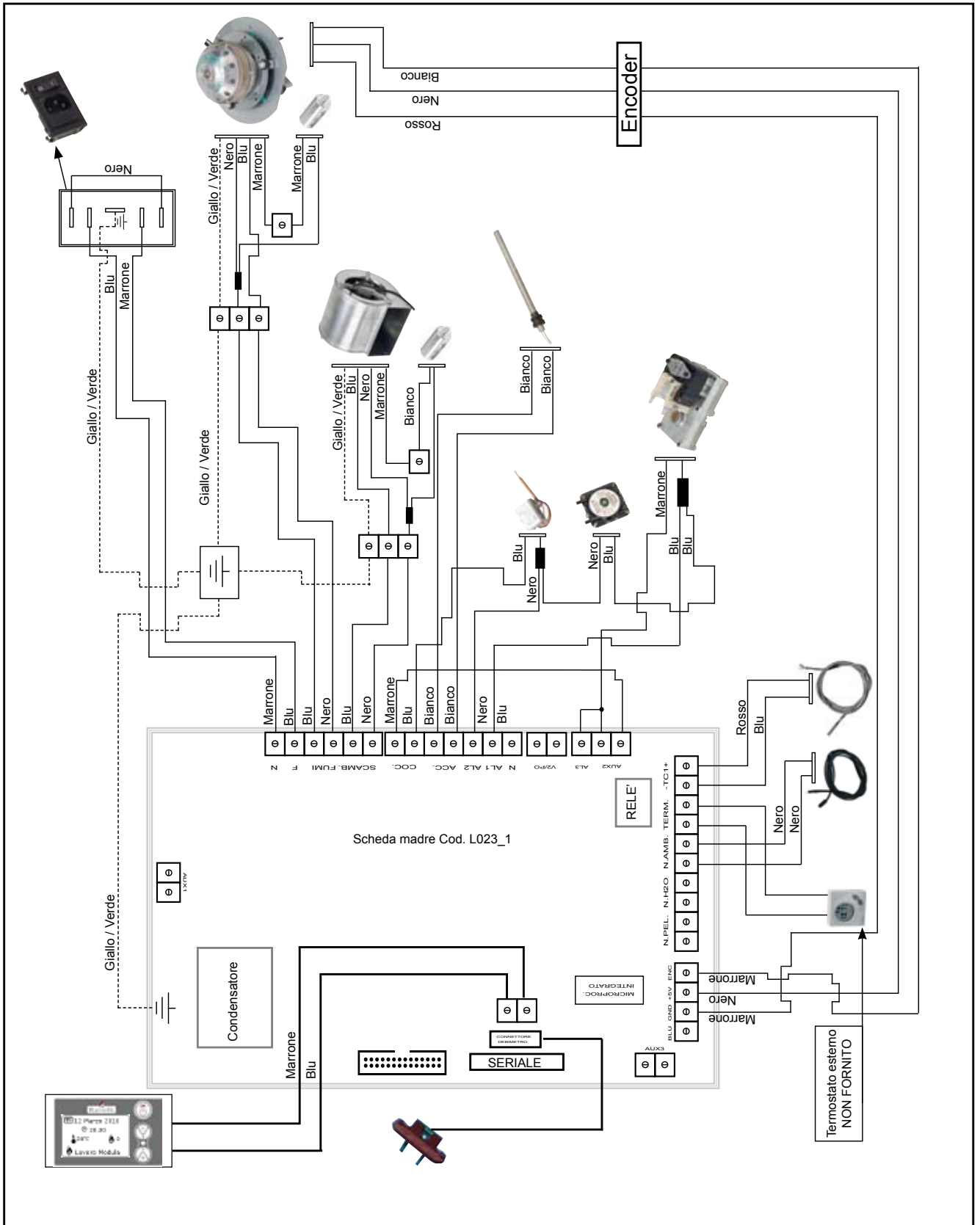

## 11.2 Single duct

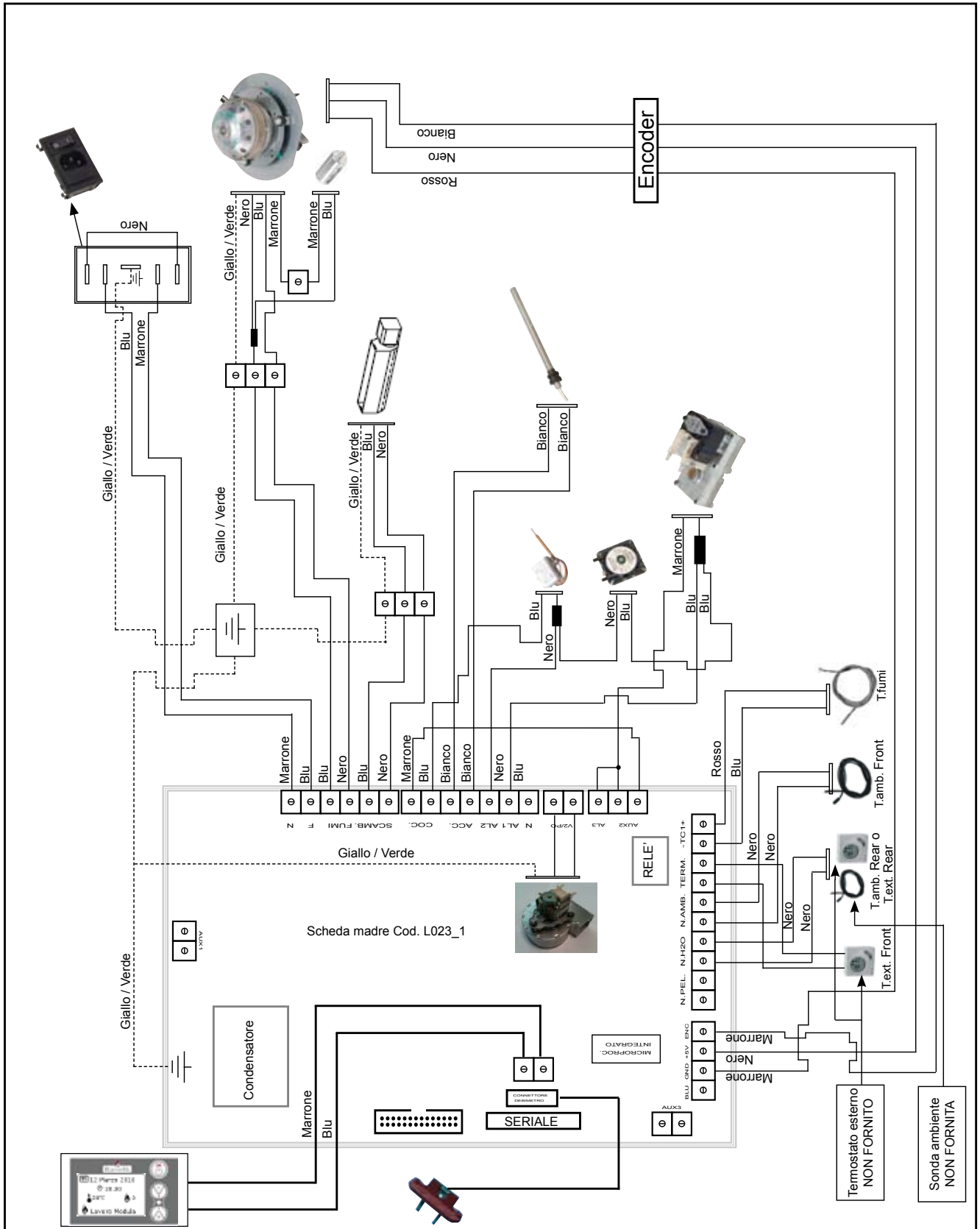

**11.3 Double duct**

